

Specifications

Nominal Voltage		6 V
Capacity (25°C)	20HR(5.25V)	2.8Ah
	10HR(5.25V)	2.6Ah
	1HR(4.80V)	1.82Ah
Dimension	Length	66 ± 1mm (2.60inch)
	Width	33 ± 0.5mm (1.30inch)
	Height	97 ± 1mm (3.82inch)
	Total Height	104 ± 1mm (4.09inch)
Approx. Weight		0.49kg (1.08lbs) ± 5%
Terminal type		T1
Internal resistance (Fully charged, 25°C)		Approx. 32mΩ
Capacity affected by temperature (20HR)	40°C	102%
	25°C	100%
	0°C	85%
	-15°C	65%
Self-discharge (25°C)	3 month	Remaining Capacity: 91%
	6 month	Remaining Capacity: 82%
	12 month	Remaining Capacity: 65%
Nominal operating temperature		25°C ± 3°C (77°F ± 5°F)
Operating temperature range	Discharge	-15°C ~ 50°C (5°F ~ 122°F)
	Charge	-10°C ~ 50°C (14°F ~ 122°F)
	Storage	-20°C ~ 50°C (-4°F ~ 122°F)
Float charging voltage(25°C)		6.80 to 6.90V Temperature compensation: -9mV/°C
Cyclic charging voltage(25°C)		7.25 to 7.45V Temperature compensation: -15mV/°C
Maximum charging current		0.84A
Terminal material		Copper
Maximum discharge current		42A(5 sec.)
Designed floating life(20°C)		10years

Dimensions

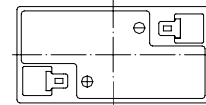
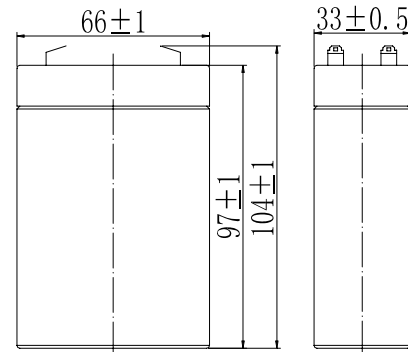

Terminal

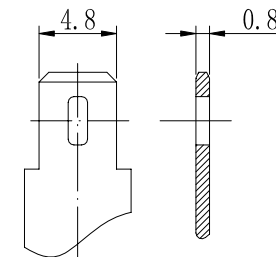

Terminal T1

- ◆ Absorbent glass mat technology;
- ◆ Recognized by UL & CE;
- ◆ ABS container.

Constant Current Discharge Characteristics (A, 25°C)

F.V/TIME	5min	10min	15min	30min	60min	2h	3h	4h	5h	10h	20h
4.80V	10.6	6.72	5.32	2.97	1.82	0.99	0.71	0.57	0.49	0.26	0.14
4.95V	10.3	6.52	5.19	2.91	1.79	0.99	0.71	0.57	0.48	0.26	0.14
5.10V	9.90	6.25	5.00	2.82	1.75	0.98	0.70	0.56	0.48	0.26	0.14
5.25V	9.47	5.98	4.83	2.75	1.71	0.97	0.70	0.56	0.48	0.26	0.14
5.40V	8.94	5.64	4.58	2.65	1.66	0.94	0.68	0.54	0.46	0.26	0.14

Constant Power Discharge Characteristics (Watt, 25°C)

F.V/TIME	5min	10min	15min	30min	60min	2h	3h	4h	5h	10h	20h
4.80V	59.4	37.9	30.3	17.0	10.5	5.82	4.24	3.40	2.90	1.59	0.85
4.95V	57.6	36.8	29.6	16.7	10.4	5.78	4.22	3.38	2.88	1.58	0.85
5.10V	55.2	35.2	28.5	16.2	10.1	5.73	4.19	3.36	2.86	1.57	0.85
5.25V	52.8	33.7	27.5	15.8	9.92	5.65	4.16	3.33	2.84	1.56	0.84
5.40V	49.9	31.8	26.1	15.2	9.61	5.50	4.03	3.23	2.76	1.53	0.82

Note: The above characteristics data can be obtained within three charge/discharge cycles.

Discharge Characteristics(25°C)

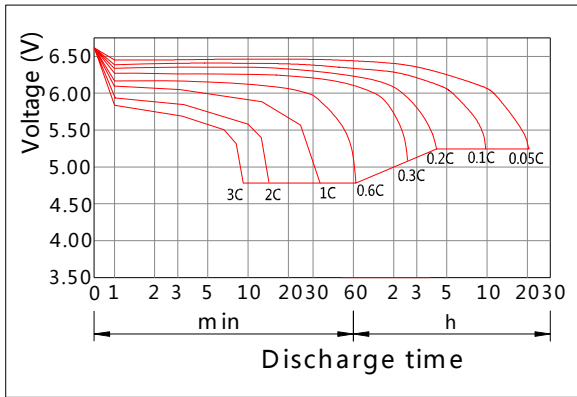

Charging Characteristics(25°C)

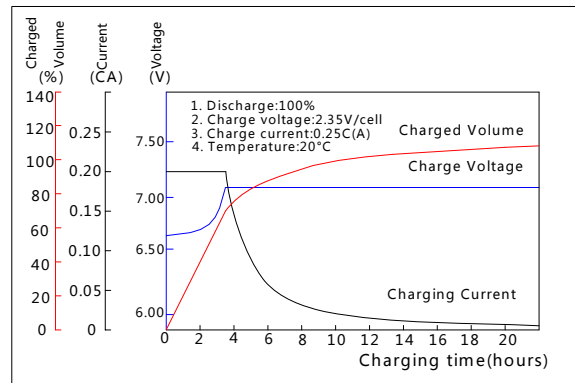

Effect of Temperature on Capacity

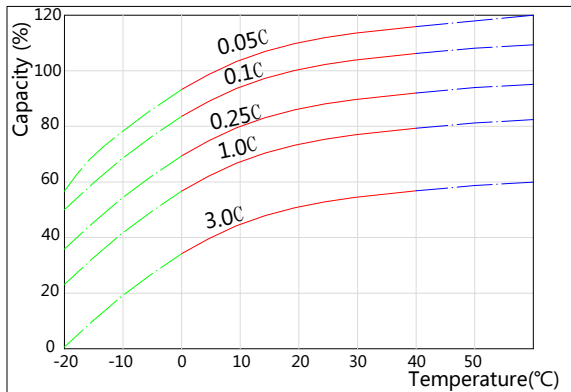

Self-discharge Characteristics

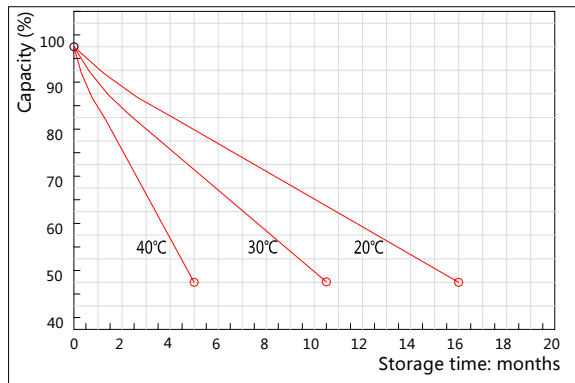

The Relationship for Open Circuit Voltage and Residual Capacity (25°C)

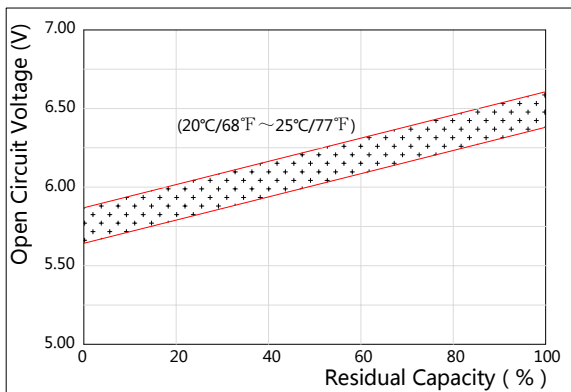

The Relationship for Charging Voltage and Temperature

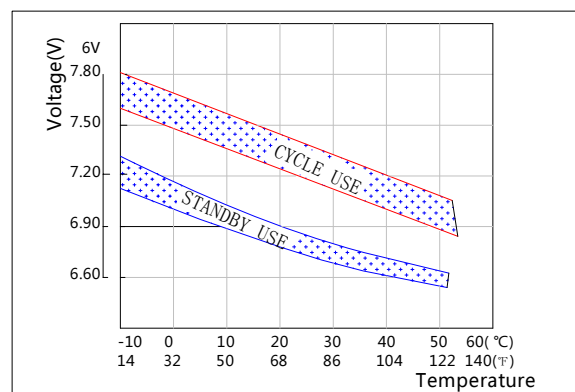

Floating Life on Temperature

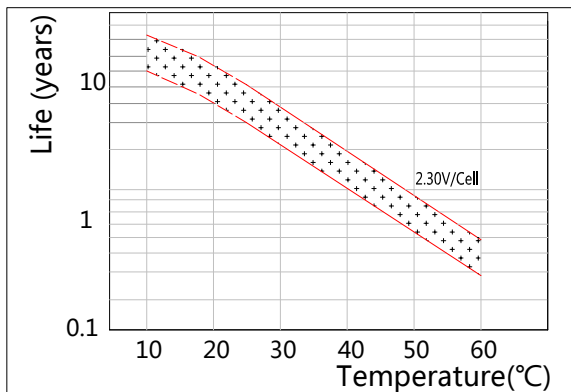

Cycle Life on D.O.D(25°C)

