

Powered by



XTV 121100 ▶ 12V 110AH

XTV 121100 is a general battery up to 12 years expected life in standby service or more than 260 cycles at 100% discharge in cycle service. XTV has a wider operating temperature range, which makes them more suitable for the systems in harsh conditions.



► Specification

Cells Per Unit	6
Voltage Per Unit	12
Capacity	110AH @ 20hr-rate to 1.75V per cell @ 25°C(77°F)
Weight	Approx. 34.2 kg(75.4 lbs)
Maximum Discharge Current	800A(5sec)
Internal Resistance	Approx. 3.4mΩ
Operating Temperature Range	Discharge: -20°C~50°C (-4°F~122°F) Charge: -20°C~50°C (-4°F~122°F) Storage: -15°C~40°C (5°F~104°F)
Nominal Operating Temperature Range	25°C±3°C (77°F±5°F)
Float Charging Voltage	13.5 to 13.8 VDC/unit Average at 25°C (77°F)
Recommended Maximum Charging Current Limit	33 A
Equalization and Cycle Service	14.4 to 15.0 VDC/unit Average at 25°C (77°F)
Self Discharge	CSB Batteries can be stored for more than 6 months at 25°C(77°F). Please charge batteries before using. For higher temperatures the time interval will be shorter.
Terminal	I2-Thread lead alloy recessed terminal to accept M6/M8 bolt
Container Material	Polypropylene(UL 94-HB) & Flammability resistance of (UL 94-V0) can be available upon request.



CSB-manufactured **VRLA** (Absorbent Glass Mat type) batteries are UL-recognized components under UL1989.

CSB is also certified by ISO 9001 and ISO 14001.

► Dimensions :

Unit: mm (inch)	Overall Height (H)	Container height (h)	Length (L)	Width (W)
	217.3±2.0 (8.56±0.08)	213.9±2.0 (8.42±0.08)	343.0±2.5 (13.50±0.10)	170.0±2.0 (6.69±0.08)

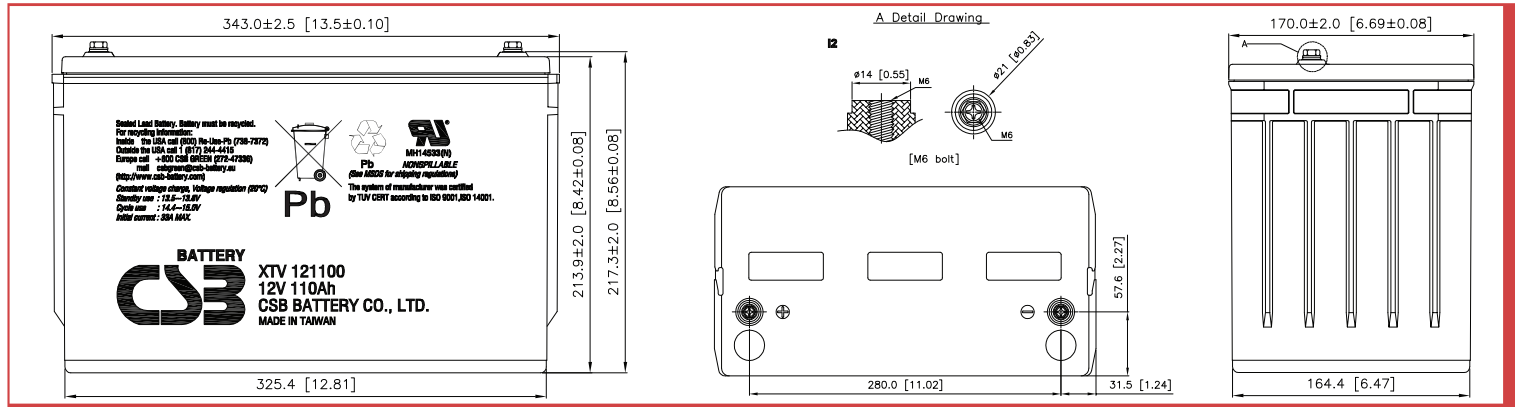

Constant Current Discharge Characteristics Unit:A (25°C,77°F)

F.V/Time	5MIN	10MIN	15MIN	30MIN	60MIN	90MIN	2HR	3HR	5HR	8HR	10HR	20HR
1.60V	425	307	235	138	78.6	55.8	43.7	31.2	20.0	13.1	10.7	5.53
1.67V	382	289	227	135	77.5	55.4	43.5	30.8	19.9	13.0	10.6	5.52
1.70V	364	276	222	134	77.2	55.0	43.0	30.7	19.7	12.9	10.5	5.51
1.75V	339	254	207	130	75.6	54.0	42.5	30.3	19.5	12.8	10.4	5.50
1.80V	289	232	188	123	72.3	52.1	41.2	29.4	18.9	12.6	10.2	5.33
1.85V	231	200	163	114	67.1	48.8	38.9	28.2	18.2	12.0	9.86	5.15

Constant Power Discharge Characteristics Unit:W (25°C,77°F)

F.V/Time	5MIN	10MIN	15MIN	30MIN	60MIN	90MIN	2HR	3HR	5HR	8HR	10HR	20HR
1.60V	4173	3108	2509	1543	890	640	505	363	236	155	126	66.7
1.67V	3921	2975	2418	1515	884	635	502	361	235	154	125	66.6
1.70V	3745	2914	2368	1508	880	633	501	359	234	153	124	66.1
1.75V	3384	2783	2251	1464	862	622	493	356	231	152	123	65.7
1.80V	2988	2573	2053	1411	827	600	479	346	228	149	122	64.9
1.85V	2719	2220	1834	1323	773	567	455	334	218	145	118	62.3

Ratings presented herein are subject to revision without notice. Please refer to www.csb-battery.com to confirm the latest version.

Trickle (or Float) Service Life

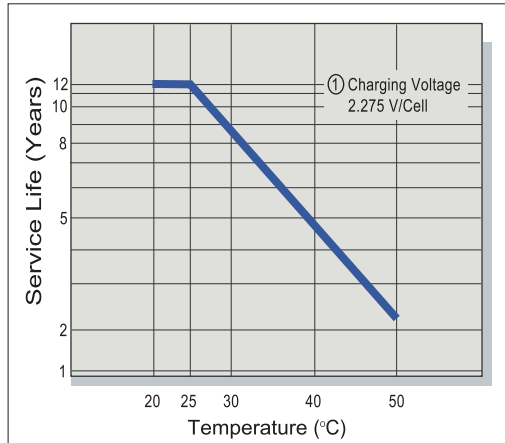

Capacity Retention Characteristic

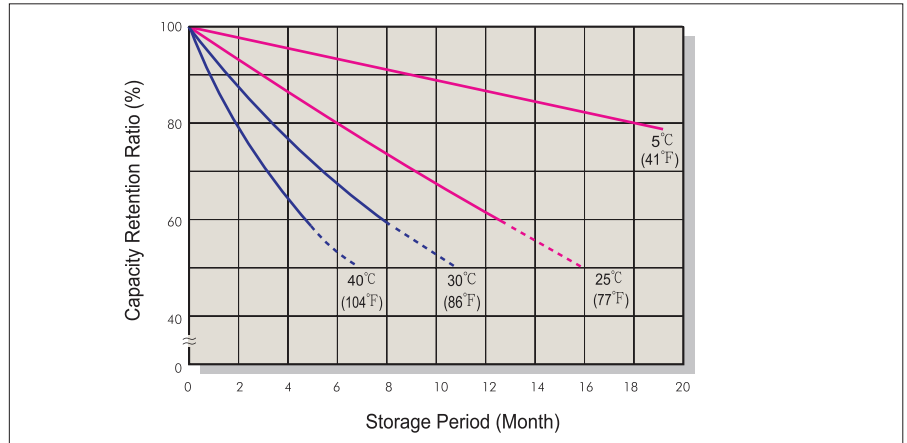

Battery Voltage and Charge Time for Standby Use

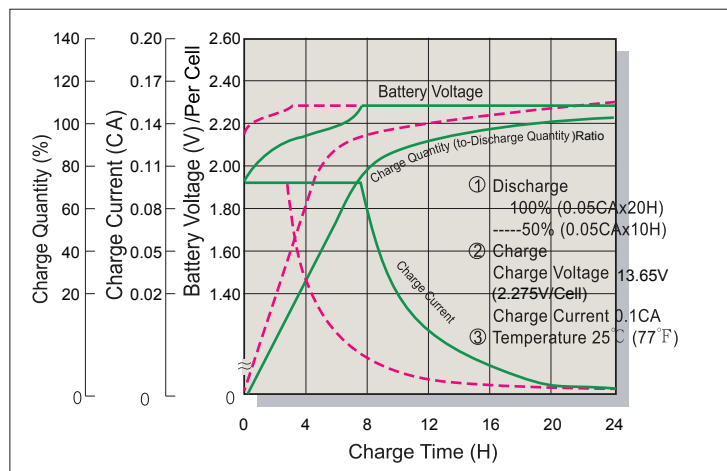

Series Cycle Service Life

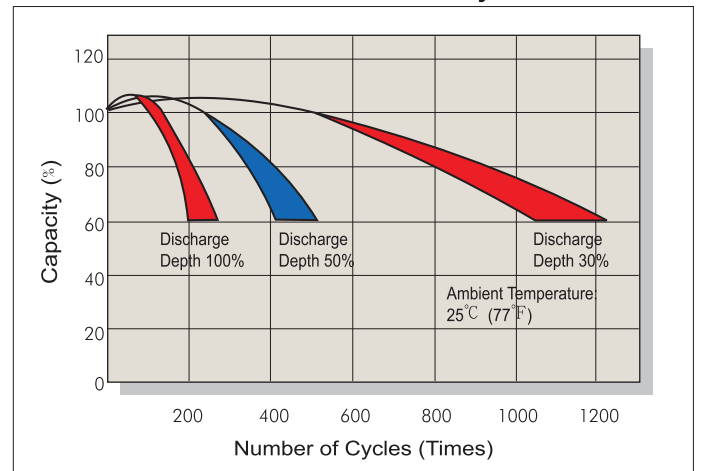

Battery Voltage and Charge Time for Cycle Use

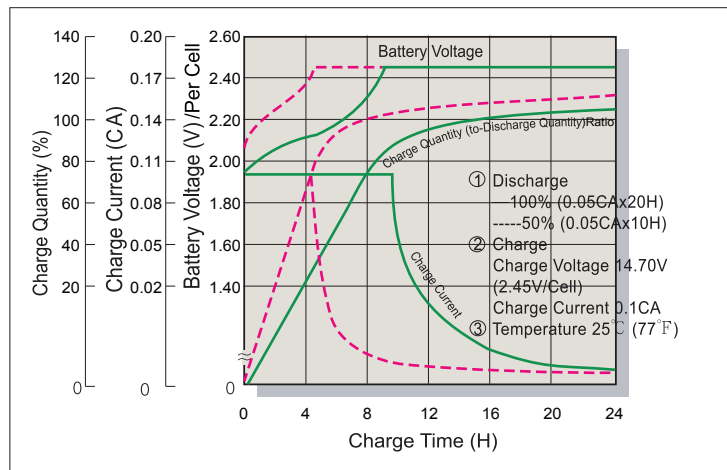

Terminal Voltage (V) and Discharge Time

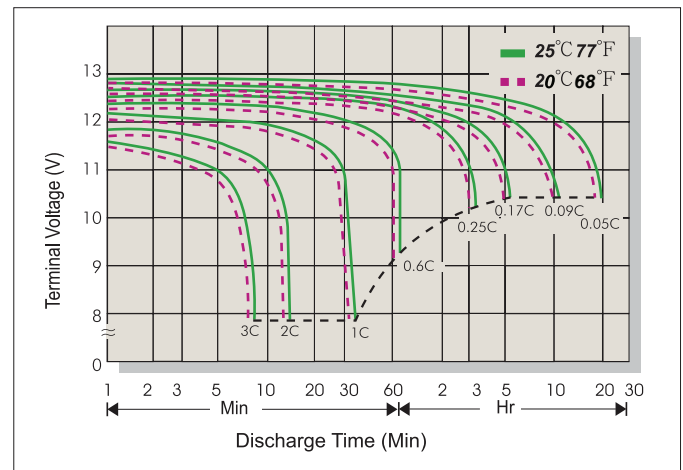

Charging Procedures

Application	Charge Voltage(V/Cell)			Max. Charge Current
	Temperature	Set Point	Allowable Range	
Cycle Use	25°C(77°F)	2.45	2.40~2.50	0.3C
Standby	25°C(77°F)	2.275	2.25~2.30	

Discharge Current VS. Discharge Voltage

Final Discharge Voltage V/Cell	1.75	1.70	1.60	1.30
Discharge Current(A)	0.2C>(A)	0.2C<(A)<0.5C	0.5C<(A)<1.0C	(A)>1.0C

Sales Office URL: WWW.CSB-BATTERY.COM

GLOBAL HQ
CSB BATTERY CO., LTD. (TAIWAN)
 Tel : +886-2-2880-5600
 Fax : +886-2-2888-3300
 mail : service@csb-battery.com.tw

BEIJING OFFICE. (CHINA)
CSB BATTERY TECHNOLOGIES (BEIJING) CO., LTD.
 Tel : +86-10-5820-5336/5338
 Fax : +86-10-58203053
 mail : chinasl@csb-battery.com

AMERICA HQ
CSB BATTERY TECHNOLOGIES INC. (U.S.A)
 Tel : +1-817-244-7777/1-(800)3-CSB-USA(272872)
 Fax : +1-817-244-4445
 mail : csb@csb-battery.com

SHANGHAI OFFICE. (CHINA)
CSB BATTERY LOGISTIC (SHANGHAI) CO., LTD.
 Tel : +86-21-5046-1622/5046-0833
 Fax : +86-21-5064-1046
 mail : chinasl@csb-battery.com

EUROPE HQ
CSB Battery Europe BV.
 Tel : +31(0)-180-418-140
 Fax : +31(0)-180-418-327
 mail : eurosales@csb-battery.eu

SHENZHEN OFFICE. (CHINA)
CSB BATTERY LOGISTIC (SHANGHAI) CO., LTD.
 Tel : +86-755-8831-6488/6396/6356
 Fax : +86-755-8831-6548
 mail : she@csb-battery.com.cn