

Powered by



# UPS12460 ▶

UPS 12460 is specially designed for high efficient discharge application. Its characteristics are high energy density, small footprint and high discharge efficiency. It can be used for more than 260 cycles at 100% discharge in cycle service, up to 5 years in standby service.



## ► Specification

<b>Cells Per Unit</b>	6
<b>Voltage Per Unit</b>	12
	460W @ 5min-rate to Watt(1.60V)/pcs @25 °C(77°F)
<b>Capacity</b>	
<b>Weight</b>	Approx. 2.50 kg(5.51 lbs)
<b>Maximum Discharge Current</b>	130A(5sec)
<b>Internal Resistance</b>	Approx. 18.0mΩ
<b>Operating Temperature Range</b>	Discharge: -15°C~50°C ( 5°F~122°F) Charge: -15 °C~40°C ( 5°F~104°F) Storage: -15°C~40°C ( 5°F~104°F)
<b>Nominal Operating Temperature Range</b>	25°C±3°C(77°F±5°F)
<b>Float Charging Voltage</b>	13.5 to 13.8 VDC/unit Average at 25°C(77°F)
<b>Recommended Maximum Charging Current Limit</b>	3.60A
<b>Equalization and Cycle Service</b>	14.4 to 15.0 VDC/unit Average at 25°C(77°F)
<b>Self Discharge</b>	CSB Batteries can be stored for more than 6 months at 25°C(77°F). Please charge batteries before using. For higher temperatures the time interval will be shorter.
<b>Terminal</b>	F2-Faston Tab 250
<b>Container Material</b>	ABS(UL 94-HB) & Flammability resistance of (UL 94-V0) can be available upon request.



CSB-manufactured **VRLA (Absorbent Glass Mat type)** batteries are UL-recognized components under UL1989.

CSB is also certified by ISO 9001 and ISO 14001.

## ► Dimensions :

Unit: mm (inch)	Overall Height (H)	Container height (h)	Length (L)	Width (W)
	98.3±1.0(3.87±0.04)	94.0±1.0 (3.70±0.04)	151.0±2.0 (5.95±0.08)	65.0±1.0 (2.56±0.04)

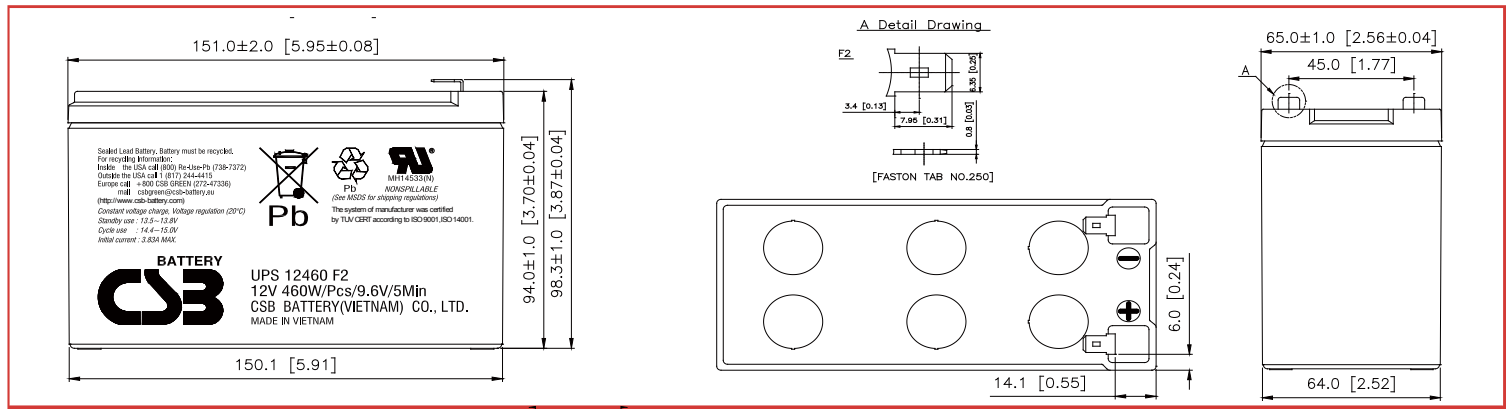

## Constant Current Discharge Characteristics Unit:A (25°C,77°F)

F.V/Time	2MIN	3MIN	4MIN	5MIN	6MIN	7MIN	8MIN	10MIN	15MIN	20MIN	30MIN	60MIN	90MIN
1.60V	77.2	63.0	52.7	44.9	39.7	35.6	32.3	27.3	19.9	15.9	11.57	6.65	4.80
1.67V	69.5	58.9	50.0	43.4	38.7	34.7	31.7	26.9	19.7	15.7	11.49	6.63	4.78
1.70V	66.0	56.9	48.6	42.4	37.9	34.0	31.1	26.5	19.6	15.6	11.44	6.60	4.75
1.75V	60.5	52.1	45.1	39.9	35.6	32.4	29.8	25.4	19.0	15.3	11.28	6.52	4.72
1.80V	53.8	46.5	41.1	36.5	33.0	30.2	27.8	24.0	18.2	14.7	10.95	6.38	4.62
1.85V	46.3	40.5	36.0	32.1	29.4	27.0	24.9	21.8	16.8	13.8	10.42	6.12	4.43

## Constant Power Discharge Characteristics Unit:W (25°C,77°F)

F.V/Time	2MIN	3MIN	4MIN	5MIN	6MIN	7MIN	8MIN	10MIN	15MIN	20MIN	30MIN	60MIN	90MIN
1.60V	710	606	520	460	412	373	343	296	224	180	133	77.3	56.4
1.67V	673	579	500	444	400	367	338	291	221	178	132	77.0	56.0
1.70V	650	561	489	435	394	362	334	288	220	178	132	76.7	56.0
1.75V	605	523	462	414	378	349	321	280	215	175	130.4	76.4	55.7
1.80V	555	482	429	387	356	327	303	266	207	168	127.5	75.1	54.7
1.85V	486	432	387	355	324	297	276	244	189	158	121.5	72.2	52.8

Ratings presented herein are subject to revision without notice. Please refer to [www.csb-battery.com](http://www.csb-battery.com) to confirm the latest version.

## Trickle (or Float) Service Life

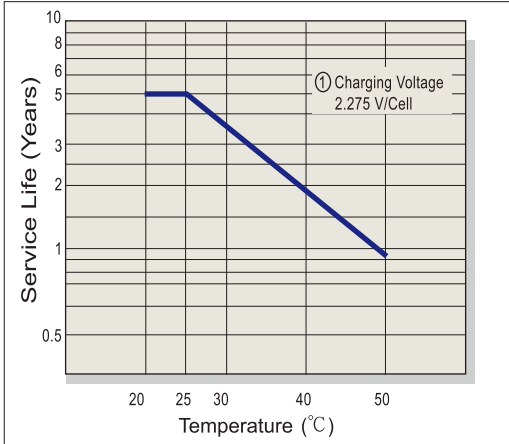

## Capacity Retention Characteristic

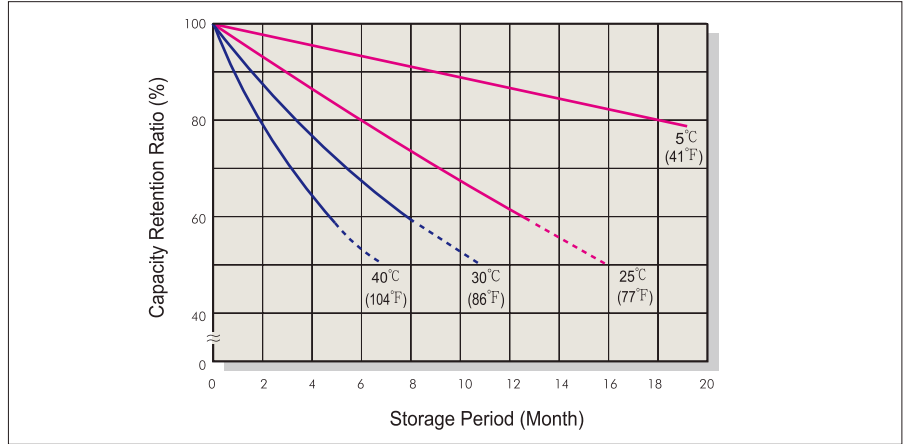

## Battery Voltage and Charge Time for Standby Use

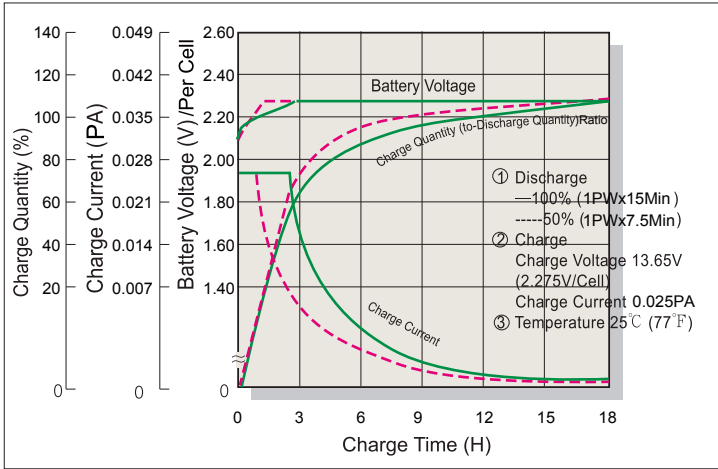

## Cycle Service Life

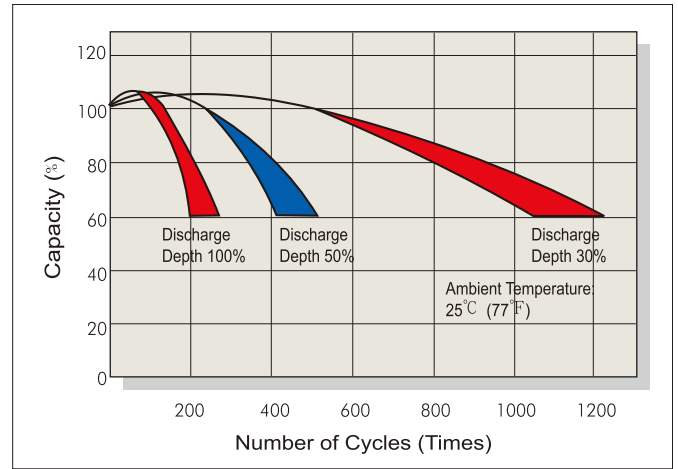

## Battery Voltage and Charge Time for Cycle Use

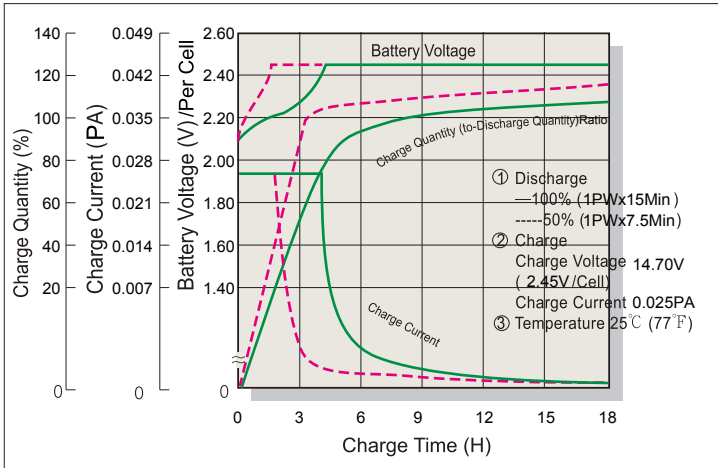

## Terminal Voltage (V) and Discharge Time

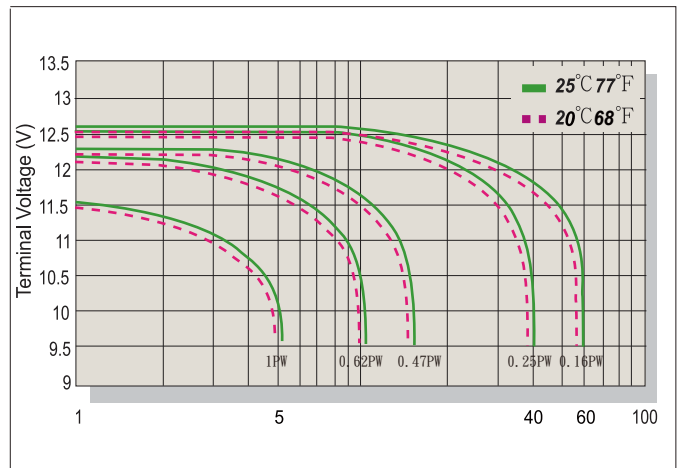

## Charging Procedures

Application	Charge Voltage(V/Cell)			Max.Charge Current
	Temperature	Set Point	Allowable Range	
Cycle Use	25°C(77°F)	2.45	2.40~2.50	0.1PA
Standby	25°C(77°F)	2.275	2.25~2.30	

## Discharge Current VS. Discharge Voltage

Final Discharge Voltage V/Cell	1.75	1.70	1.60	1.30
Discharge Power(W)	0.1P>(W)	0.1P≤(W)<0.25P	0.25P≤(W)<1.0P	(W)≥1.0P

P: For single cell wattage at 15 minute rate to 1.67V per cell.

Sales Office URL: [WWW.CSB-BATTERY.COM](http://WWW.CSB-BATTERY.COM)

**CSB BATTERY CO., LTD.**  
TAIWAN OFFICE  
Tel: +886-2-2880-5600  
Fax: +886-2-2888-3300  
E-mail: service@csb-battery.com.tw

**CSB BATTERY LOGISTICS (SHANGHAI) CO., LTD.**  
SHANGHAI OFFICE  
Tel: +86-21-5046-1622, 5046-0833  
Fax: +86-21-5064-1046  
E-mail: chinasl@csb-battery.com

**CSB BATTERY TECHNOLOGIES, INC.**  
USA OFFICE  
Tel: +1-817-244-7777/1-8003 CSBUSA(272872)  
Fax: +1-817-244-4445  
E-mail: csb@csb-battery.com

**CSB BATTERY TECHNOLOGIES (BEIJING) CO., LTD.**  
BEIJING OFFICE  
Tel: +86-10-5820-5336/5338  
Fax: +86-10-58203053  
E-mail: chinasl@csb-battery.com

**CSB BATTERY OF NETHERLANDS B.V.**  
EUROPE OFFICE  
Tel: +31(0)180 418 140  
Fax: +31(0)180 418 327  
E-mail: eurosales@csb-battery.eu

**CSB BATTERY LOGISTICS (SHANGHAI) CO., LTD.**  
SHENZHEN OFFICE  
Tel: +86-755-8831-6488/6396/16356  
Fax: +86-755-8831-6548  
E-mail: she@csb-battery.com.cn