

Powered by



# UPS12360 6▶

UPS 123606 is specially designed for high efficient discharge application. Its characteristics are high energy density, small footprint and high discharge efficiency. It can be used for more than 260 cycles at 100% discharge in cycle service, up to 5 years in standby service.



## ► Specification

<b>Cells Per Unit</b>	6
<b>Voltage Per Unit</b>	12
	360W @ 5min-rate to Watt(1.60V)/pcs @25°C (77°F)
<b>Capacity</b>	
<b>Weight</b>	Approx. 1.97 kg(4.34 lbs)
<b>Maximum Discharge Current</b>	100/130A(5sec)
<b>Internal Resistance</b>	Approx. 22mΩ
<b>Operating Temperature Range</b>	Discharge: -15°C~50°C ( 5°F~122°F) Charge: -15°C~40°C ( 5°F~104°F) Storage: -15°C~40°C ( 5°F~104°F)
<b>Nominal Operating Temperature Range</b>	25°C±3°C (77°F±5°F)
<b>Float Charging Voltage</b>	13.5 to 13.8 VDC/unit Average at 25°C (77°F)
<b>Recommended Maximum Charging Current Limit</b>	3.0A
<b>Equalization and Cycle Service</b>	14.4 to 15.0 VDC/unit Average at 25°C (77°F)
<b>Self Discharge</b>	CSB Batteries can be stored for more than 6 months at 25°C (77°F). Please charge batteries before using. For higher temperatures the time interval will be shorter.
<b>Terminal</b>	F1/F2-Faston Tab 180/250
<b>Container Material</b>	ABS(UL 94-HB) & Flammability resistance of (UL 94-V0) can be available upon request.



CSB-manufactured **VRLA** (Absorbent Glass Mat type) batteries are UL-recognized components under UL1989.

CSB is also certified by ISO 9001 and ISO 14001.

Dimensions :	Overall Height (H)	Container height (h)	Length (L)	Width (W)
Unit: mm (inch)	98.3±1.0 (3.87±0.04)	94.0±1.0 (3.70±0.04)	151.0±2.0 (5.94±0.08)	51.0±1.0 (2.01±0.04)

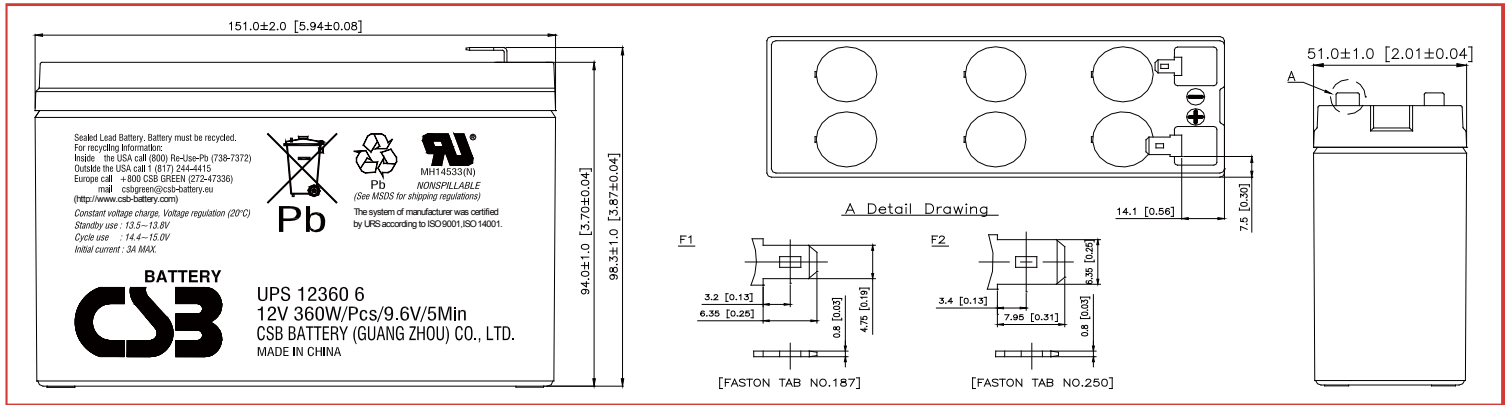

## Constant Current Discharge Characteristics Unit:A (25°C,77°F)

F.V/Time	2MIN	3MIN	4MIN	5MIN	6MIN	7MIN	8MIN	10MIN	15MIN	20MIN	30MIN	60MIN	90MIN
1.60V	61.7	49.0	41.2	35.3	31.1	27.7	24.7	20.7	15.2	12.1	8.90	5.10	3.64
1.67V	55.0	45.7	38.8	33.7	30.1	26.7	24.0	20.4	15.1	12.1	8.84	5.06	3.62
1.70V	52.2	43.8	37.5	32.6	29.2	26.0	23.6	20.1	15.0	12.0	8.81	5.02	3.61
1.75V	47.1	40.0	34.6	30.8	27.2	24.6	22.5	19.2	14.6	11.8	8.68	4.97	3.58
1.80V	42.4	36.0	31.4	27.6	24.8	22.4	20.7	18.0	13.9	11.3	8.40	4.88	3.52
1.85V	36.8	31.3	27.0	24.1	21.7	20.1	18.5	16.4	12.7	10.5	7.95	4.63	3.38

## Constant Power Discharge Characteristics Unit:W (25°C,77°F)

F.V/Time	2MIN	3MIN	4MIN	5MIN	6MIN	7MIN	8MIN	10MIN	15MIN	20MIN	30MIN	60MIN	90MIN
1.60V	558	467	403	360	318	284	259	222	169	135	100.0	58.4	42.4
1.67V	529	444	388	347	308	277	254	218	167	134	99.1	58.0	42.3
1.70V	510	436	381	340	301	272	250	216	165	133	98.7	57.7	42.0
1.75V	472	408	364	319	287	261	238	210	159	132	98.2	57.3	41.7
1.80V	423	376	330	293	264	244	225	199	154	126	96.0	56.4	41.2
1.85V	374	324	287	261	238	220	204	183	142	119	91.7	54.6	40.2

Ratings presented herein are subject to revision without notice. Please refer to [www.csb-battery.com](http://www.csb-battery.com) to confirm the latest version.

## Trickle (or Float) Service Life

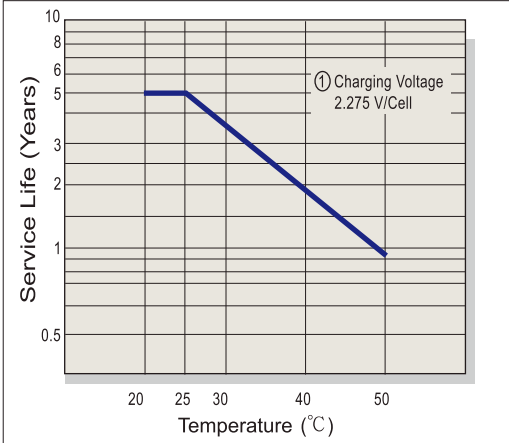

## Capacity Retention Characteristic

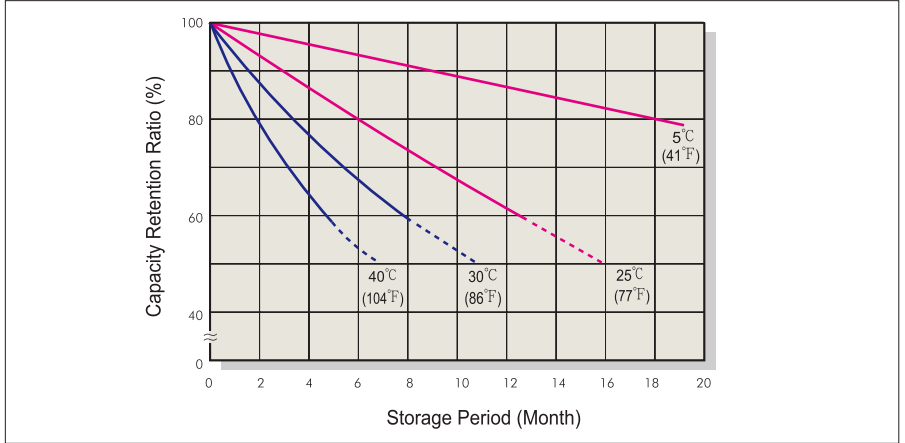

## Battery Voltage and Charge Time for Standby Use

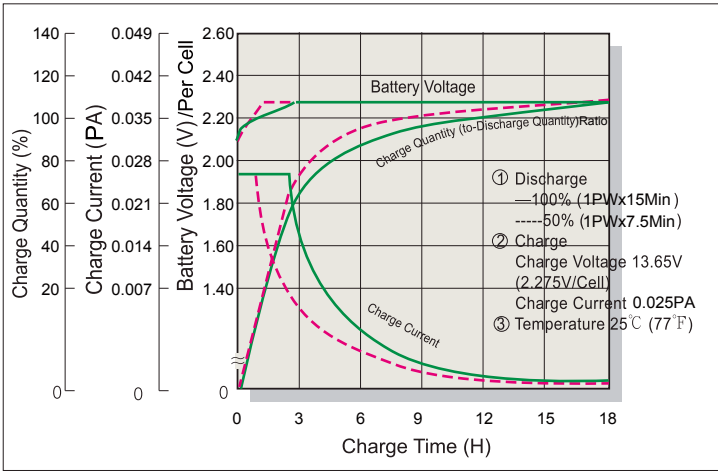

## Cycle Service Life

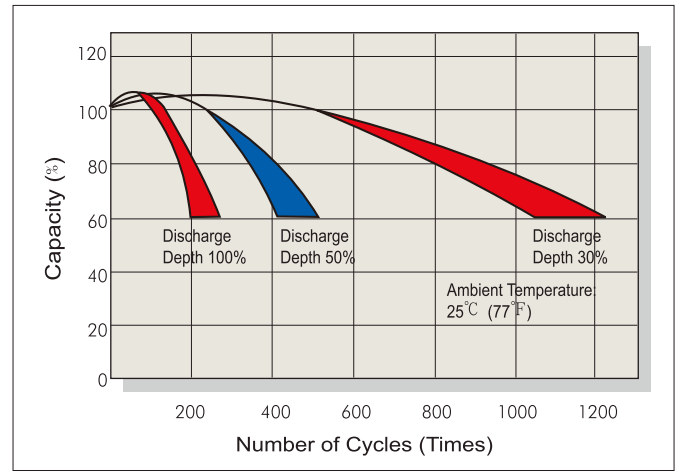

## Battery Voltage and Charge Time for Cycle Use

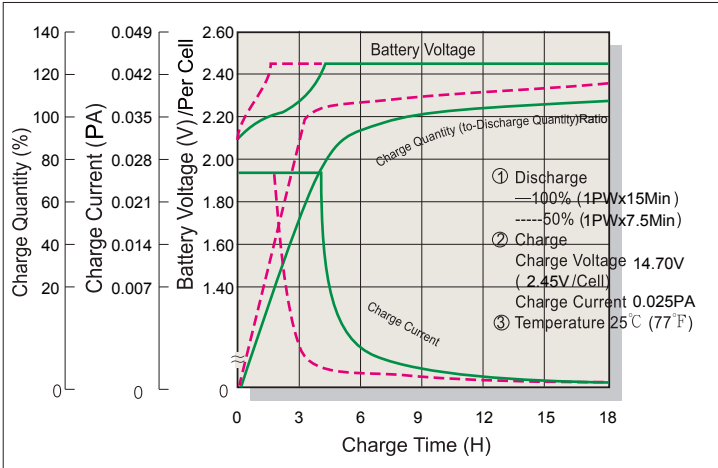

## Terminal Voltage (V) and Discharge Time

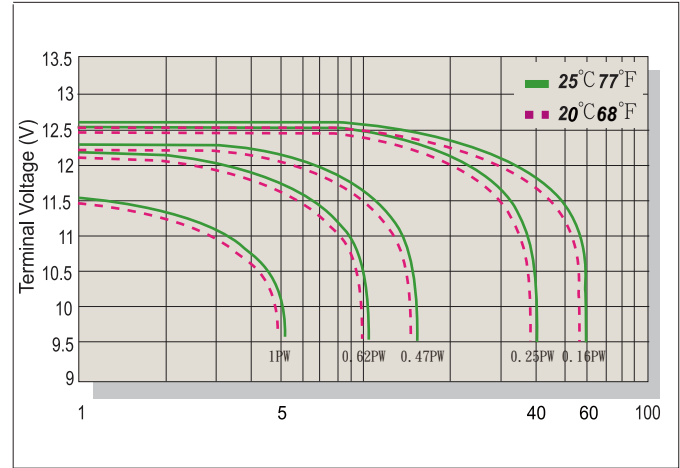

## Charging Procedures

Application	Charge Voltage(V/Cell)			Max.Charge Current
	Temperature	Set Point	Allowable Range	
Cycle Use	25°C(77°F)	2.45	2.40~2.50	0.1PA
Standby	25°C(77°F)	2.275	2.25~2.30	

## Discharge Current VS. Discharge Voltage

Final Discharge Voltage V/Cell	1.75	1.70	1.60	1.30
Discharge Power(W)	0.1P>(W)	0.1P≤(W)<0.25P	0.25P≤(W)<1.0P	(W)≥1.0P

P: For single cell wattage at 15 minute rate to 1.67V per cell.

Sales Office URL: [WWW.CSB-BATTERY.COM](http://WWW.CSB-BATTERY.COM)

**GLOBAL HQ**  
**CSB BATTERY CO., LTD. (TAIWAN)**  
 Tel : +886-2-2880-5600  
 Fax : +886-2-2888-3300  
 mail : service@csb-battery.com.tw

**BEIJING OFFICE. (CHINA)**  
**CSB BATTERY TECHNOLOGIES (BEIJING) CO., LTD.**  
 Tel : +86-10-5820-5336/5338  
 Fax : +86-10--58203053  
 mail : chinasl@csb-battery.com

**AMERICA HQ**  
**CSB BATTERY TECHNOLOGIES INC. (U.S.A)**  
 Tel : +1-817-244-7777/1-(800)3-CSB-USA(272872)  
 Fax : +1-817-244-4445  
 mail : csb@csb-battery.com

**SHANGHAI OFFICE. (CHINA)**  
**CSB BATTERY LOGISTIC (SHANGHAI) CO., LTD.**  
 Tel : +86-21-5046-1622/5046-0833  
 Fax : +86-21-5064-1046  
 mail : chinasl@csb-battery.com

**EUROPE HQ**  
**CSB Battery Europe BV.**  
 Tel : +31(0)-180-418-140  
 Fax : +31(0)-180-418-327  
 mail : eurosales@csb-battery.eu

**SHENZHEN OFFICE.( CHINA )**  
**CSB BATTERY LOGISTIC ( SHANGHAI ) CO., LTD.**  
 Tel : +86-755-8831-6488/6396/6356  
 Fax : +86-755-8831-6548  
 mail : she@csb-battery.com.cn