



# TPL 12900 ▶ 12V 90Ah

TPL 12900 is a front terminal battery up to 12 years expected life under normal float charge As with all CSB batteries, all are rechargeable, highly efficient, leak proof and maintenance free.



CSB-manufactured **VRLA** (Absorbent Glass Mat type) batteries are UL-recognized components under UL1989.

CSB is also certified by ISO 9001 and ISO 14001.

## ► Specification

Cells Per Unit	6
Voltage Per Unit	12
Capacity	90Ah @ 8hr-rate to 1.75V per cell @25 °C (77°F)
Weight	Approx. 36.3kg(80.02 lbs)
Maximum Discharge Current	800A(5sec)
Internal Resistance	Approx. 4.5 mΩ
Operating Temperature Range	Discharge: -15°C~50°C ( 5°F~122°F) Charge: -15°C~40°C ( 5°F~104°F) Storage: -15°C~40°C ( 5°F~104°F)
Nominal Operating Temperature Range	25°C±3°C(77°F±5°F)
Float Charging Voltage	2.275 ± 0.025V / Cell at 25 °C (77°F) Temp. Coefficient ±3.3mV/°C(±1.8mV/°F)
Recommended Maximum Charging Current Limit	27A
Equalization / Cycle Use Charging Voltage	2.45V Temps coefficient ±0.05mV/°C(±1.8mV/°F)
Terminal	I2-Thread lead alloy recessed terminal to accept M6 bolt
Terminal Hardware Initial Torque	120-in-lbs.(13.58 N-m)
Container Material	ABS(UL94-V0) & (UL94-HB) / L.O.I higher than 28

## ► Dimensions :

Unit: mm (inch)

Overall Height (H)	Length (L)	Width (W)
256.7±2.5 (10.11±0.10)	512.0±2.5 (20.16±0.10)	112.8±1.5 (4.44±0.06)

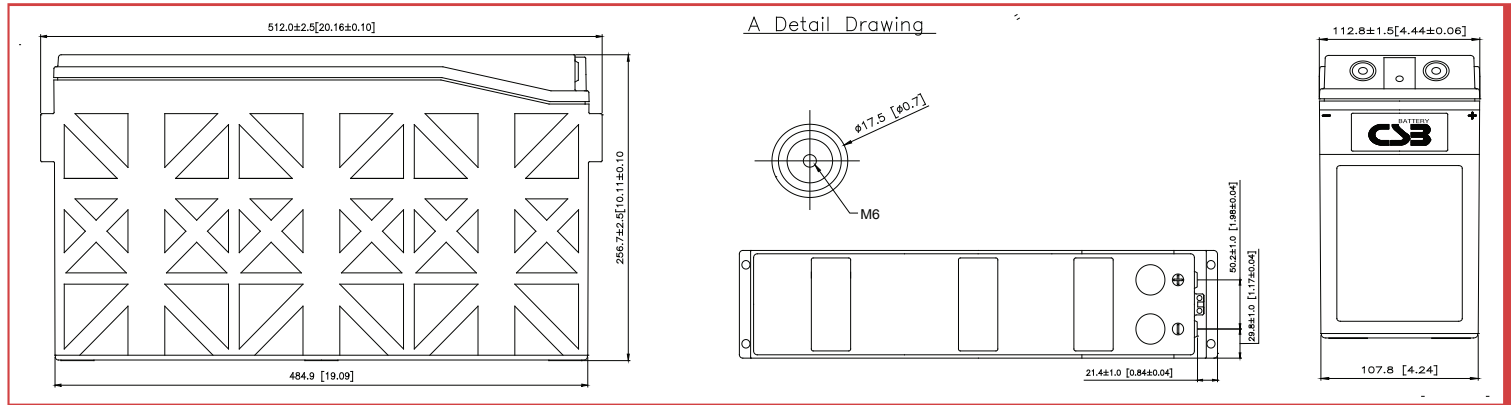

## Constant Current Discharge Characteristics Unit:A (25°C ,77°F)

F.V/Time	15MIN	30MIN	60MIN	90MIN	2HR	3HR	4HR	5HR	6HR	7HR	8HR	10HR	20HR
1.67V	167	106	62.2	45.1	36.1	26.6	21.4	17.8	15.2	13.2	11.7	9.56	5.01
1.70V	159	102	60.4	44.4	35.7	26.3	21.2	17.5	15.0	13.1	11.5	9.45	4.95
1.75V	143	96.2	57.8	43.3	35.2	25.6	20.5	16.9	14.4	12.6	11.3	9.23	4.84
1.80V	127	88.4	54.7	41.7	34.2	24.8	19.6	16.2	14.0	12.2	10.9	9.00	4.73
1.83V	117	83.0	52.6	40.5	33.2	23.9	18.9	15.9	13.6	11.9	10.6	8.77	4.61
1.85V	110	79.5	50.6	39.0	32.5	23.3	18.4	15.5	13.3	11.6	10.4	8.55	4.50
1.90V	94.6	70.7	46.3	35.3	28.9	21.3	16.9	14.1	12.0	10.6	9.45	7.82	4.16

## Constant Power Discharge Characteristics Unit:W (25°C ,77°F)

F.V/Time	15MIN	30MIN	60MIN	90MIN	2HR	3HR	4HR	5HR	6HR	7HR	8HR	10HR	20HR
1.67V	1,772	1,145	681	497	401	298	241	201	172	149	132	108	56.8
1.70V	1,700	1,117	673	494	397	294	240	200	170	148	131	107	56.6
1.75V	1,556	1,057	649	482	389	285	235	194	166	146	130	106	56.1
1.80V	1,397	982	623	468	378	277	228	191	164	143	127	105	55.5
1.83V	1,300	932	603	456	369	272	222	187	161	140	124	102	54.6
1.85V	1,239	900	586	443	362	267	218	183	158	138	123	101	53.5
1.90V	1,087	822	545	418	343	254	202	169	144	127	113	94.0	50.1

Ratings presented herein are subject to revision without notice. Please refer to [www.csb-battery.com](http://www.csb-battery.com) to confirm the latest version.

### Trickle (or Float) Service Life

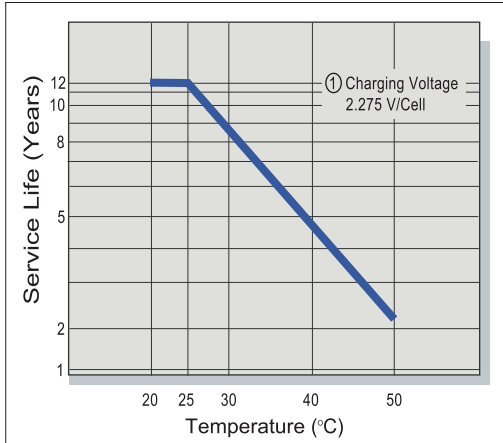

### Capacity Retention Characteristic

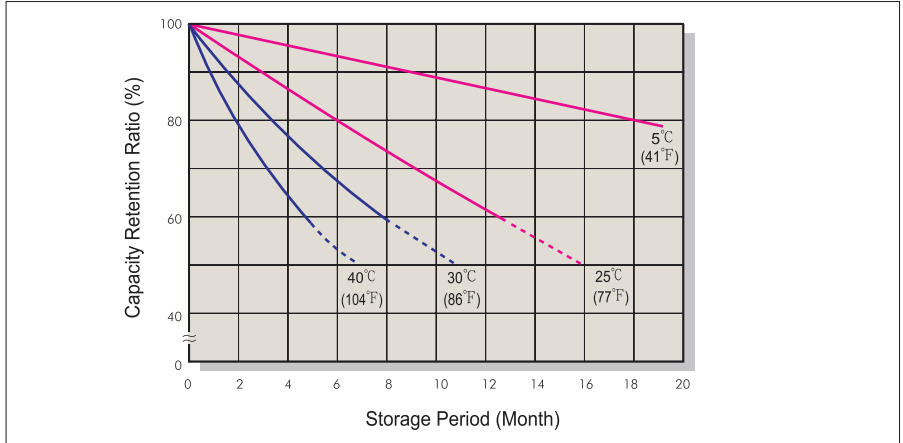

### Battery Voltage and Charge Time for Standby Use

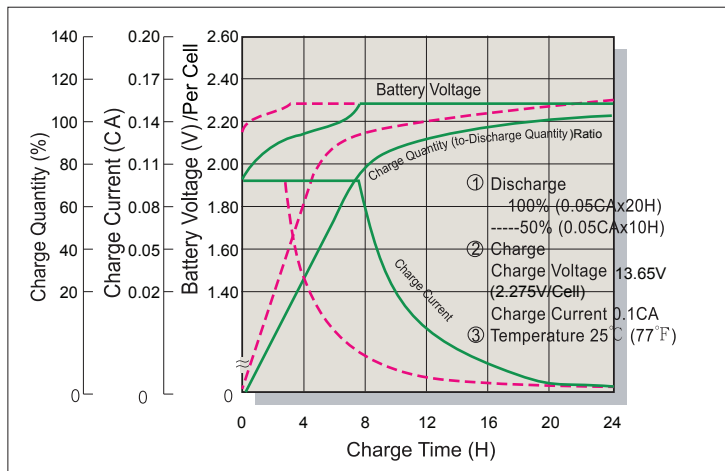

### Cycle Service Life

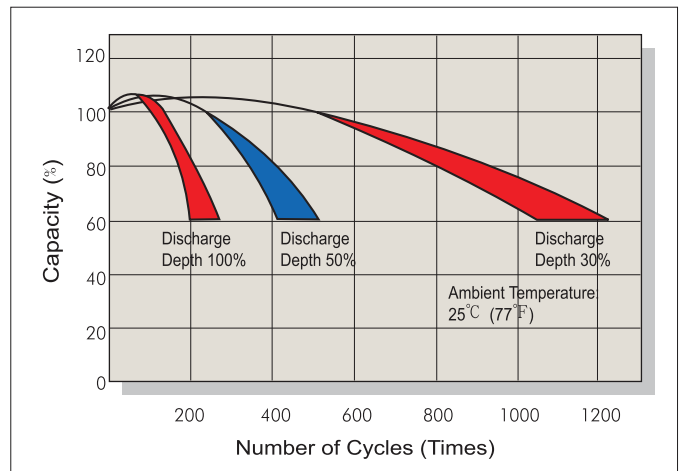

### Battery Voltage and Charge Time for Cycle Use

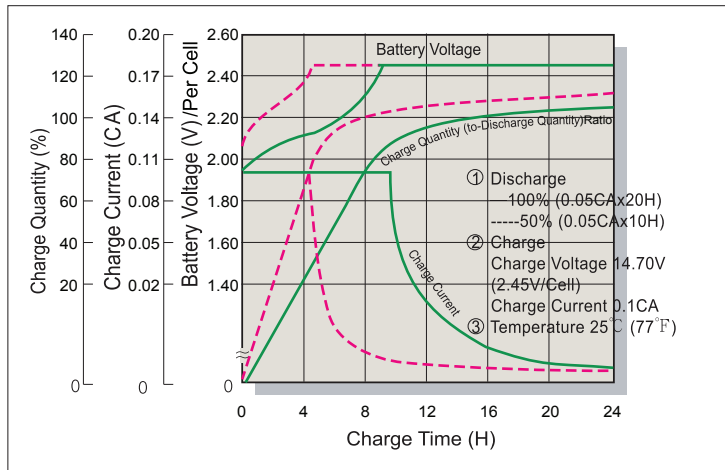

### Terminal Voltage (V) and Discharge Time

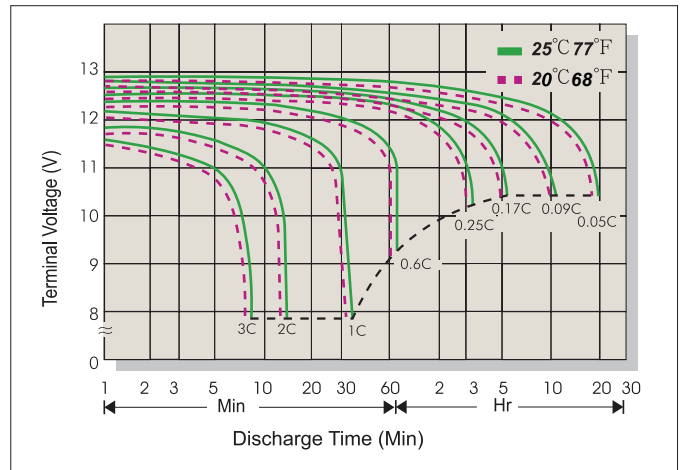

### Charging Procedures

Application	Charge Voltage(V/Cell)			Max. Charge Current
	Temperature	Set Point	Allowable Range	
Cycle Use	25°C(77°F)	2.45	2.40~2.50	0.3C
Standby	25°C(77°F)	2.275	2.25~2.30	

### Discharge Current VS. Discharge Voltage

Final Discharge Voltage V/Cell	1.75	1.70	1.60	1.30
Discharge Current(A)	0.2C>(A)	0.2C<(A)<0.5C	0.5C<(A)<1.0C	(A)>1.0C

Sales Office URL: [WWW.CSB-BATTERY.COM](http://WWW.CSB-BATTERY.COM)

**GLOBAL HQ**  
**CSB BATTERY CO., LTD. (TAIWAN)**  
 Tel : +886-2-2880-5600  
 Fax : +886-2-2888-3300  
 mail : service@csb-battery.com.tw

**BEIJING OFFICE. (CHINA)**  
**CSB BATTERY TECHNOLOGIES (BEIJING) CO., LTD.**  
 Tel : +86-10-5820-5336/5338  
 Fax : +86-10-58203053  
 mail : chinasl@csb-battery.com

**AMERICA HQ**  
**CSB BATTERY TECHNOLOGIES INC. (U.S.A)**  
 Tel : +1-817-244-7777/1-(800)3-CSB-USA(272872)  
 Fax : +1-817-244-4445  
 mail : csb@csb-battery.com

**SHANGHAI OFFICE. (CHINA)**  
**CSB BATTERY LOGISTIC (SHANGHAI) CO., LTD.**  
 Tel : +86-21-5046-1622/5046-0833  
 Fax : +86-21-5064-1046  
 mail : chinasl@csb-battery.com

**EUROPE HQ**  
**CSB Battery Europe BV.**  
 Tel : +31(0)-180-418-140  
 Fax : +31(0)-180-418-327  
 mail : eurosales@csb-battery.eu

**SHENZHEN OFFICE. (CHINA)**  
**CSB BATTERY LOGISTIC (SHANGHAI) CO., LTD.**  
 Tel : +86-755-8831-6488/6396/6356  
 Fax : +86-755-8831-6548  
 mail : she@csb-battery.com.cn