

Powered by



TPL 12800 ▶ 12V 80Ah

TPL 12800 is a front terminal battery up to 12 years expected life under normal float charge As with all CSB batteries, all are rechargeable, highly efficient, leak proof and maintenance free.



CSB-manufactured **VRLA** (Absorbent Glass Mat type) batteries are UL-recognized components under UL1989.

CSB is also certified by ISO 9001 and ISO 14001.

► Specification

Cells Per Unit	6
Voltage Per Unit	12
Capacity	80Ah @ 8hr-rate to 1.75V per cell @25 °C (77°F)
Weight	Approx. 36.3kg(80.02 lbs)
Maximum Discharge Current	800A(5sec)
Internal Resistance	Approx. 4.5 mΩ
Operating Temperature Range	Discharge: -15°C~50°C (5°F~122°F) Charge: -15°C~40°C (5°F~104°F) Storage: -15°C~40°C (5°F~104°F)
Nominal Operating Temperature Range	25°C±3°C(77°F±5°F)
Float Charging Voltage	2.275 ± 0.025V / Cell at 25 °C (77°F) Temp. Coefficient ±3.3mV/°C (± 1.8mV/°F)
Recommended Maximum Charging Current Limit	24A
Equalization / Cycle Use Charging Voltage	2.45V Temps coefficient ±0.05mV/°C (± 1.8mV/°F)
Terminal	I2-Thread lead alloy recessed terminal to accept M6 bolt
Terminal Hardware Initial Torque	120-in-lbs.(13.58 N-m)
Container Material	ABS(UL94-V0) & (UL94-HB) / L.O.I higher than 28

► Dimensions :

Overall Height (H)	Length (L)	Width (W)
Unit: mm (inch)		
256.7±2.5 (10.11±0.10)	512.0±2.5 (20.16±0.10)	112.8±1.5 (4.44±0.06)

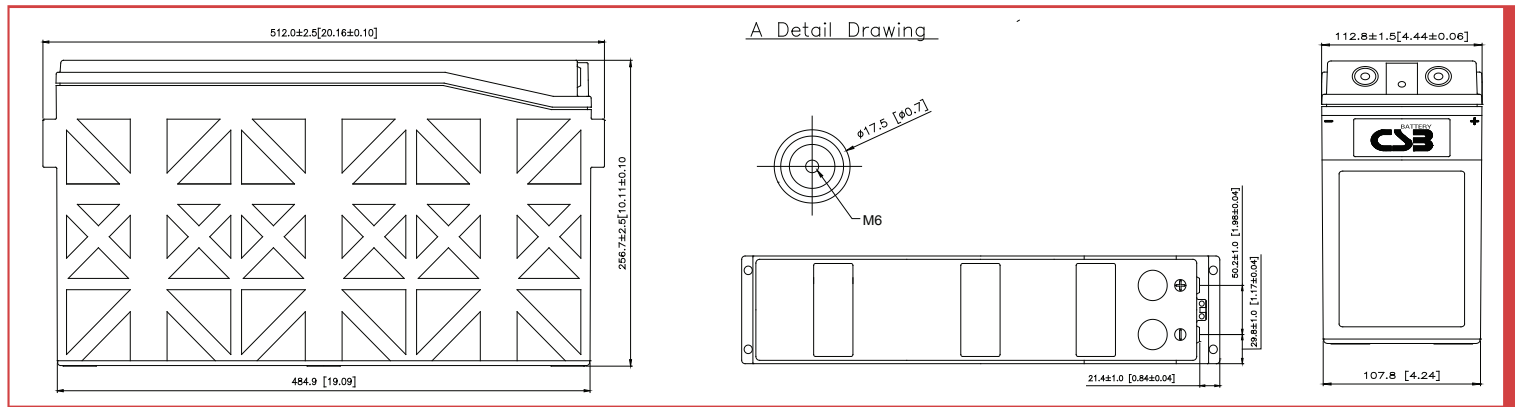

Constant Current Discharge Characteristics Unit:A (25°C ,77°F)

F.V/Time	15MIN	30MIN	60MIN	90MIN	2HR	3HR	4HR	5HR	6HR	7HR	8HR	10HR	20HR
1.67V	148	94.3	55.3	40.4	32.1	23.7	19.1	15.8	13.5	11.8	10.4	8.50	4.45
1.70V	140	90.8	53.6	39.3	31.5	23.4	18.8	15.6	13.3	11.6	10.2	8.40	4.40
1.75V	126	84.0	51.1	37.8	30.3	22.8	18.3	15.0	12.8	11.2	10.0	8.20	4.30
1.80V	111	77.1	48.3	36.0	29.0	22.1	17.4	14.5	12.5	10.9	9.65	8.00	4.20
1.83V	103	72.8	46.3	34.7	28.2	21.3	16.9	14.1	12.2	10.6	9.35	7.70	4.10
1.85V	97.3	70.3	44.8	33.7	27.5	20.8	16.6	13.8	11.9	10.4	9.20	7.60	4.00
1.90V	84.1	62.9	41.2	31.4	25.7	18.9	15.0	12.5	10.7	9.40	8.40	6.95	3.70

Constant Power Discharge Characteristics Unit:W (25°C ,77°F)

F.V/Time	15MIN	30MIN	60MIN	90MIN	2HR	3HR	4HR	5HR	6HR	7HR	8HR	10HR	20HR
1.67V	1,575	1,018	606	445	357	265	214	178	152	133	118	96.2	50.5
1.70V	1,523	995	597	439	353	263	213	177	151	132	116	95.8	50.3
1.75V	1,405	946	582	431	345	261	210	173	149	129	115	94.8	49.8
1.80V	1,264	883	556	415	335	254	203	169	146	127	113	93.1	49.3
1.83V	1,174	839	539	403	327	249	199	166	143	124	111	91.7	48.5
1.85V	1,110	808	525	394	321	245	196	163	140	123	109	90.2	47.6
1.90V	967	731	485	372	305	226	180	150	128	113	101	83.5	44.5

Ratings presented herein are subject to revision without notice. Please refer to www.csb-battery.com to confirm the latest version.

Trickle (or Float) Service Life

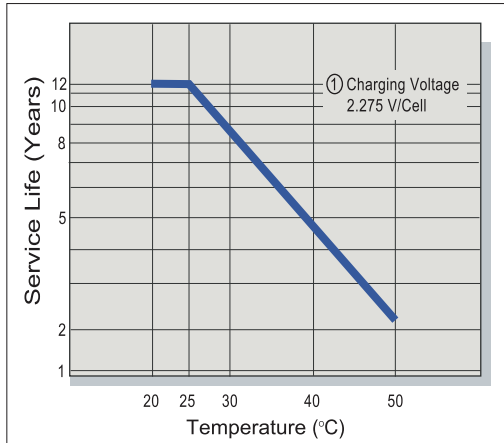

Capacity Retention Characteristic

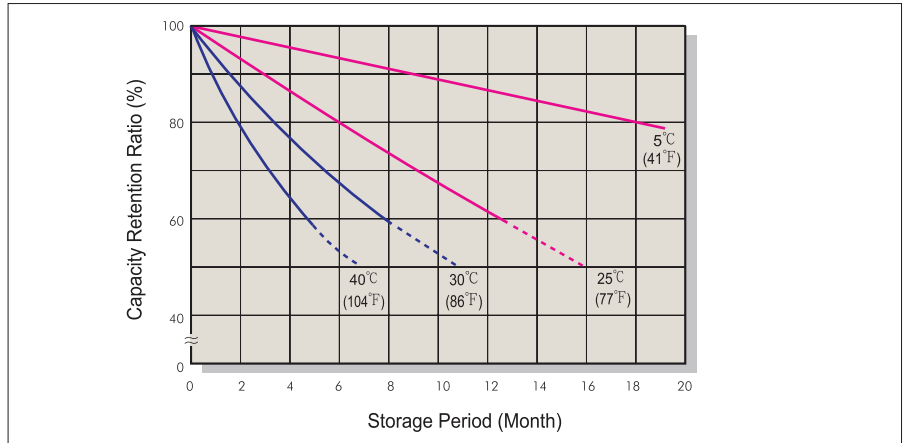

Battery Voltage and Charge Time for Standby Use

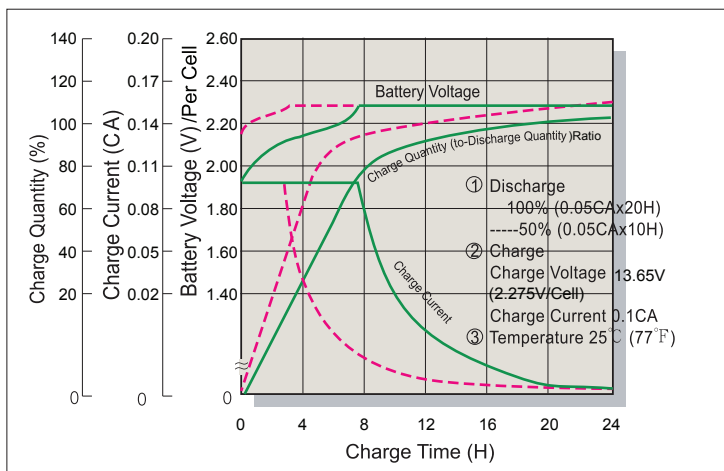

Cycle Service Life

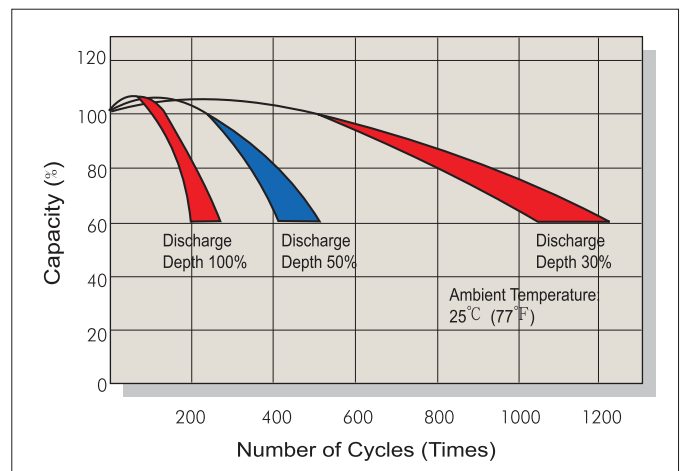

Battery Voltage and Charge Time for Cycle Use

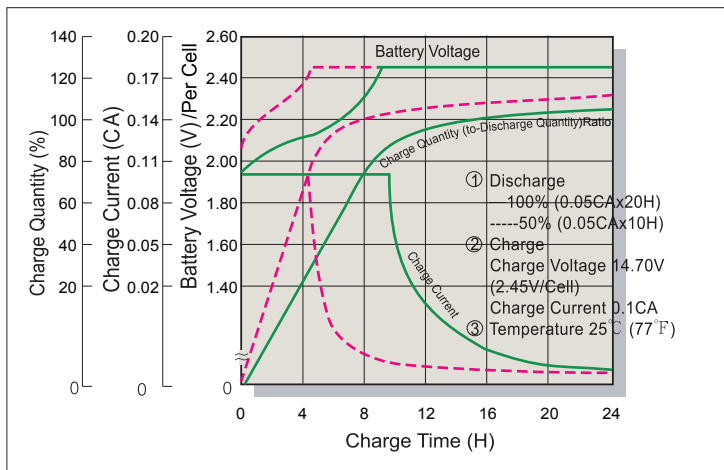

Terminal Voltage (V) and Discharge Time

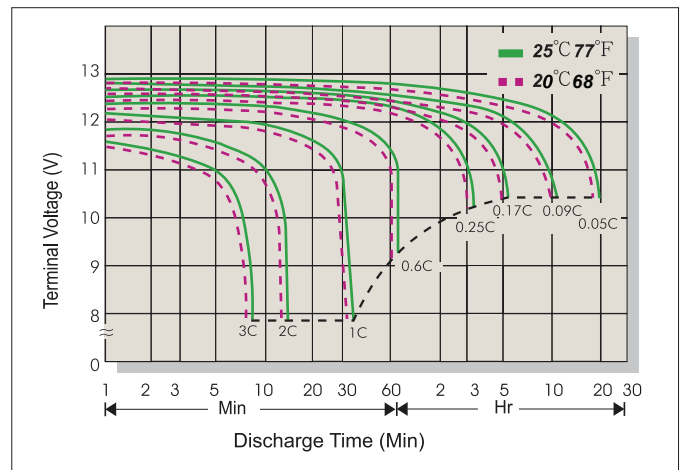

Charging Procedures

Application	Charge Voltage(V/Cell)			Max. Charge Current
	Temperature	Set Point	Allowable Range	
Cycle Use	25°C(77°F)	2.45	2.40~2.50	0.3C
Standby	25°C(77°F)	2.275	2.25~2.30	

Discharge Current VS. Discharge Voltage

Final Discharge Voltage V/Cell	1.75	1.70	1.60	1.30
Discharge Current(A)	0.2C>(A)	0.2C<(A)<0.5C	0.5C<(A)<1.0C	(A)>1.0C

Sales Office URL: WWW.CSB-BATTERY.COM

GLOBAL HQ
CSB BATTERY CO., LTD. (TAIWAN)
 Tel : +886-2-2880-5600
 Fax : +886-2-2888-3300
 mail : service@csb-battery.com.tw

BEIJING OFFICE. (CHINA)
CSB BATTERY TECHNOLOGIES (BEIJING) CO., LTD.
 Tel : +86-10-5820-5336/5338
 Fax : +86-10-58203053
 mail : chinasl@csb-battery.com

AMERICA HQ
CSB BATTERY TECHNOLOGIES INC. (U.S.A)
 Tel : +1-817-244-7777/1-(800)3-CSB-USA(272872)
 Fax : +1-817-244-4445
 mail : csb@csb-battery.com

SHANGHAI OFFICE. (CHINA)
CSB BATTERY LOGISTIC (SHANGHAI) CO., LTD.
 Tel : +86-21-5046-1622/5046-0833
 Fax : +86-21-5064-1046
 mail : chinasl@csb-battery.com

EUROPE HQ
CSB Battery Europe BV.
 Tel : +31(0)-180-418-140
 Fax : +31(0)-180-418-327
 mail : eurosales@csb-battery.eu

SHENZHEN OFFICE. (CHINA)
CSB BATTERY LOGISTIC (SHANGHAI) CO., LTD.
 Tel : +86-755-8831-6488/6396/6356
 Fax : +86-755-8831-6548
 mail : she@csb-battery.com.cn