

Powered by



TPL 121000 ▶ 12V 100Ah

TPL 121000 is a front terminal battery up to 12 years expected life under normal float charge As with all CSB batteries, all are rechargeable, highly efficient, leak proof and maintenance free.



CSB-manufactured **VRLA** (Absorbent Glass Mat type) batteries are UL-recognized components under UL1989.

CSB is also certified by ISO 9001 and ISO 14001.

► Specification

Cells Per Unit	6
Voltage Per Unit	12
Capacity	100Ah @ 8hr-rate to 1.75V per cell @25 °C (77°F)
Weight	Approx. 36.3kg(80.02 lbs)
Maximum Discharge Current	800A(5sec)
Internal Resistance	Approx. 4.5 mΩ
Operating Temperature Range	Discharge: -15°C~50°C (5 °F~122°F) Charge: -15°C~40°C (5 °F~104°F) Storage: -15°C~40°C (5 °F~104°F)
Nominal Operating Temperature Range	25°C±3°C(77°F±5°F)
Float Charging Voltage	2.275 ± 0.025V / Cell at 25 °C (77°F) Temp. Coefficient ±3.3mV/°C (± 1.8mV/°F)
Recommended Maximum Charging Current Limit	30A
Equalization / Cycle Use Charging Voltage	2.45V Temps coefficient ±0.05mV/°C (± 1.8mV/°F)
Terminal	I2-Thread lead alloy recessed terminal to accept M6 bolt
Terminal Hardware Initial Torque	120-in-lbs.(13.58 N-m)
Container Material	ABS(UL94-V0/) & (UL94-HB) / L.O.I higher than 28

► Dimensions :

Unit: mm (inch)

Overall Height (H)	Length (L)	Width (W)
256.7±2.5 (10.11±0.10)	512.0±2.5(20.16±0.10)	112.8±1.5 (4.44±0.06)

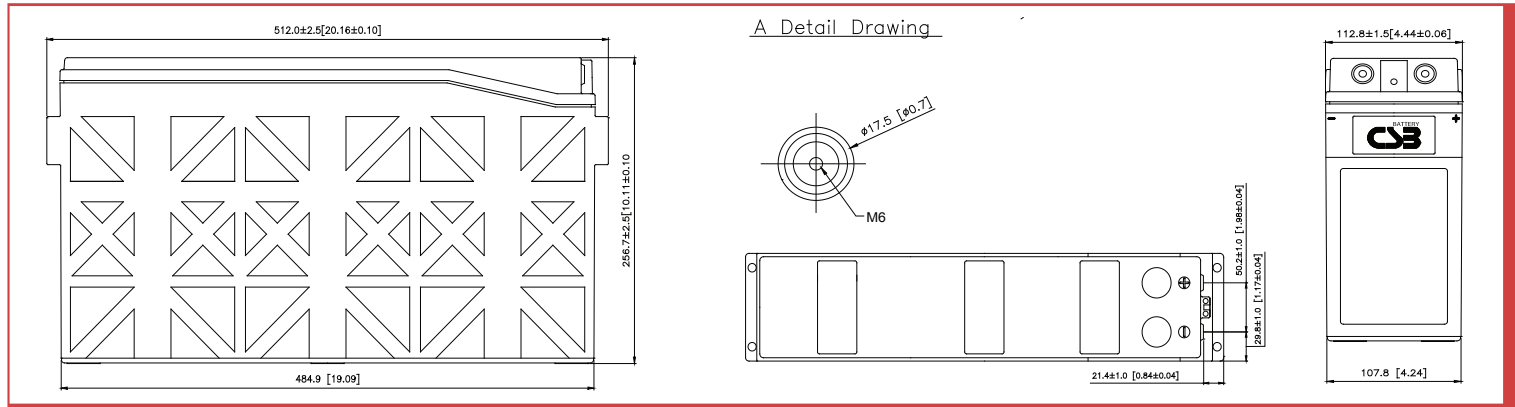

Constant Current Discharge Characteristics Unit:A (25°C ,77°F)

F.V/Time	15MIN	30MIN	60MIN	90MIN	2HR	3HR	4HR	5HR	6HR	7HR	8HR	10HR	20HR
1.67V	186	118	69.1	50.2	40.1	29.6	23.8	19.8	16.9	14.7	13.0	10.6	5.56
1.70V	175	114	67.4	49.4	39.4	29.3	23.5	19.5	16.6	14.5	12.8	10.5	5.50
1.75V	157	106	64.0	47.3	38.0	28.4	22.8	18.8	16.0	14.0	12.5	10.3	5.38
1.80V	139	98.0	60.3	44.7	36.3	27.0	21.8	18.1	15.6	13.6	12.1	10.0	5.25
1.83V	129	92.5	58.0	43.5	35.1	26.1	21.1	17.6	15.2	13.2	11.7	9.63	5.13
1.85V	122	88.2	56.0	42.5	34.3	25.4	20.7	17.2	14.8	12.9	11.5	9.50	5.00
1.90V	105	78.6	51.4	39.4	32.1	23.6	18.8	15.6	13.3	11.8	10.5	8.69	4.63

Constant Power Discharge Characteristics Unit:W (25°C ,77°F)

F.V/Time	15MIN	30MIN	60MIN	90MIN	2HR	3HR	4HR	5HR	6HR	7HR	8HR	10HR	20HR
1.67V	1,969	1,272	757	554	446	331	268	223	191	166	147	120	63.1
1.70V	1,878	1,233	746	549	439	329	267	222	189	165	145	119	62.9
1.75V	1,716	1,161	723	534	428	322	261	216	185	162	144	118	62.3
1.80V	1,549	1,075	691	511	414	313	254	212	183	159	141	116	61.6
1.83V	1,450	1,025	669	502	405	305	246	207	179	155	138	114	60.6
1.85V	1,382	994	655	496	399	299	241	203	175	153	136	113	59.5
1.90V	1,208	913	606	466	381	282	225	187	160	141	126	104	55.7

Ratings presented herein are subject to revision without notice. Please refer to www.csb-battery.com to confirm the latest version.

Trickle (or Float) Service Life

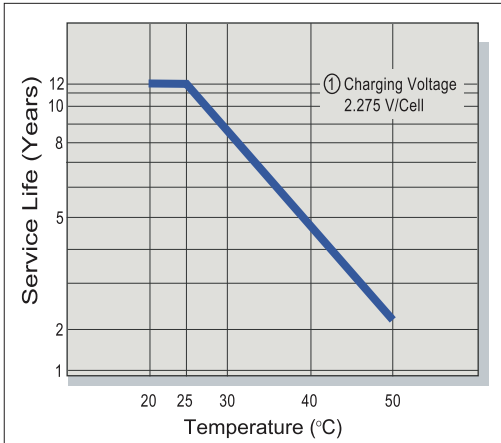

Capacity Retention Characteristic

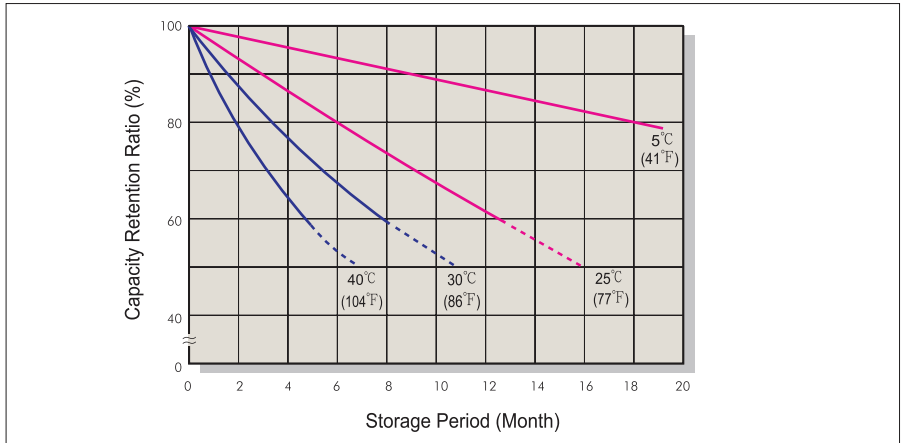

Battery Voltage and Charge Time for Standby Use

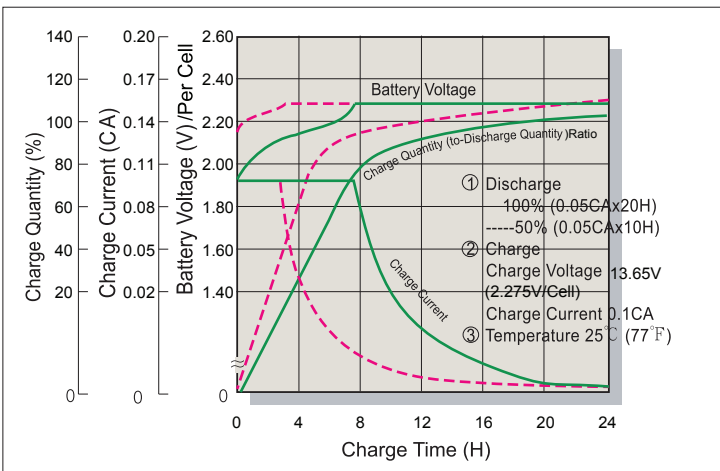

Cycle Service Life

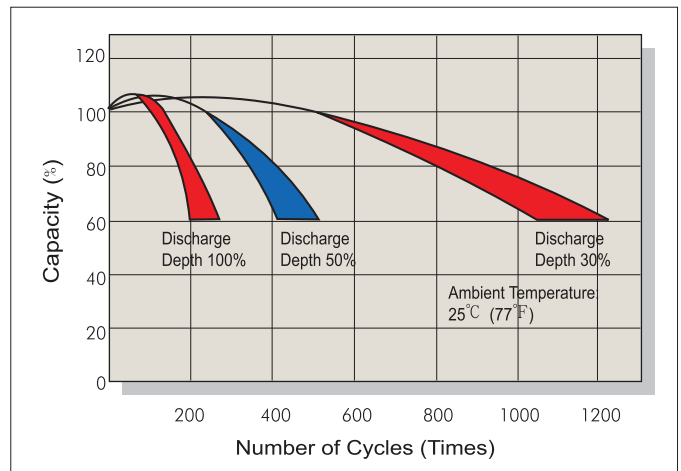

Battery Voltage and Charge Time for Cycle Use

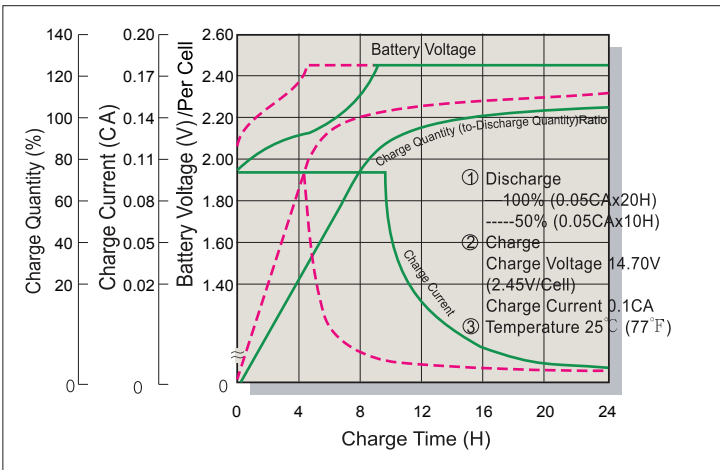

Terminal Voltage (V) and Discharge Time

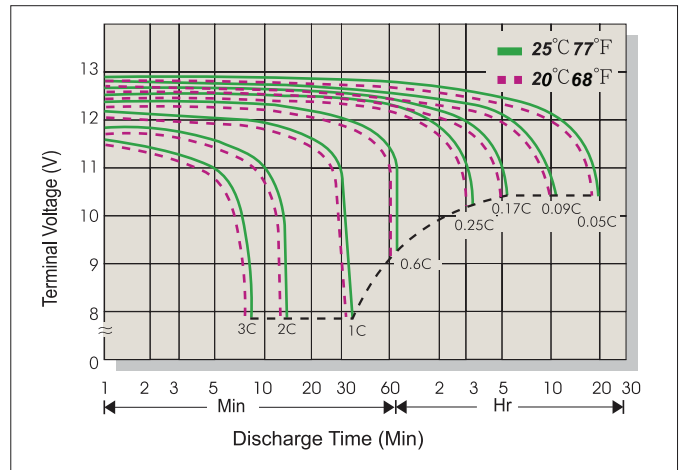

Charging Procedures

Application	Charge Voltage(V/Cell)			Max. Charge Current
	Temperature	Set Point	Allowable Range	
Cycle Use	25°C (77°F)	2.45	2.40~2.50	0.3C
Standby	25°C (77°F)	2.275	2.25~2.30	

Discharge Current VS. Discharge Voltage

Final Discharge Voltage V/Cell	1.75	1.70	1.60	1.30
Discharge Current(A)	0.2C>(A)	0.2C<(A)<0.5C	0.5C<(A)<1.0C	(A)>1.0C

Sales Office URL: WWW.CSB-BATTERY.COM

GLOBAL HQ
CSB BATTERY CO., LTD. (TAIWAN)
 Tel : +886-2-2880-5600
 Fax : +886-2-2888-3300
 mail : service@csb-battery.com.tw

BEIJING OFFICE. (CHINA)
CSB BATTERY TECHNOLOGIES (BEIJING) CO., LTD.
 Tel : +86-10-5820-5336/5338
 Fax : +86-10-58203053
 mail : chinasl@csb-battery.com

AMERICA HQ
CSB BATTERY TECHNOLOGIES INC. (U.S.A)
 Tel : +1-817-244-7777/1-(800)3-CSB-USA(272872)
 Fax : +1-817-244-4445
 mail : csb@csb-battery.com

SHANGHAI OFFICE. (CHINA)
CSB BATTERY LOGISTIC (SHANGHAI) CO., LTD.
 Tel : +86-21-5046-1622/5046-0833
 Fax : +86-21-5064-1046
 mail : chinasl@csb-battery.com

EUROPE HQ
CSB Battery Europe BV.
 Tel : +31(0)-180-418-140
 Fax : +31(0)-180-418-327
 mail : eurosales@csb-battery.eu

SHENZHEN OFFICE. (CHINA)
CSB BATTERY LOGISTIC (SHANGHAI) CO., LTD.
 Tel : +86-755-8831-6488/6396/6356
 Fax : +86-755-8831-6548
 mail : she@csb-battery.com.cn