

Powered by



# HRL 1280W ▶ 12V 80W

HRL 1280W is specially designed for high efficient discharge application. Its characteristics are high energy density, small footprint and high discharge efficiency. It can be used for more than 260 cycles at 100% discharge in cycle service, up to 8 years in standby service.



## Specification

Cells per unit	6
Voltage per unit	12
Capacity	80W @ 15min-rate to 1.67V per cell @25 °C(77°F)
Weight	Approx.6.8kg(14.99 lbs)
Maximum Discharge Current	300A(5sec)
Internal Resistance	Approx. 9 mΩ
Operating Temperature Range	Discharge: -15°C~50°C ( 5°F~122°F) Charge: -15 °C~40°C( 5°F~104°F) Storage: -15°C~40°C( 5°F~104°F)
Nominal Operating Temperature Range	25°C±3°C (77°F±5°F)
Float Charging Voltage	13.5 to 13.8 VDC/unit Average at 25°C (77°F)
Recommended Maximum Charging Current Limit	8A
Equalization and Cycle Service	14.4 to 15.0 VDC/unit Average at 25°C (77°F)
Self Discharge	CSB Batteries can be stored for more than 6 months at 25°C (77°F). Please charge batteries before using. For higher temperatures the time interval will be shorter.
Terminal	I1-Thread lead alloy recessed terminal to accept M5 bolt
Container Material	ABS(UL 94-HB) & Flammability resistance of (UL 94-V0) can be available upon request.



CSB-manufactured **VRLA** (Absorbent Glass Mat type) batteries are UL-recognized components under UL1989.

CSB is also certified by ISO 9001 and ISO 14001.

Dimensions :	Overall Height (H)	Container height (h)	Length (L)	Width (W)
Unit: mm (inch)	167.0±2.0 (6.57±0.08)	--	181.0±2.0 (7.12±0.08)	76.2±1.0 (3.00±0.04)

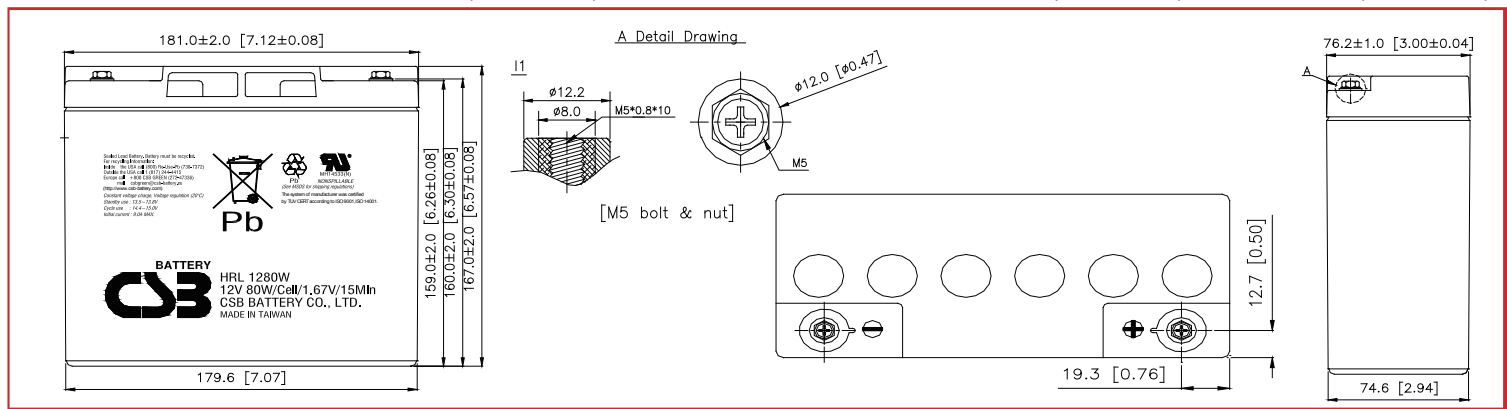

## Constant Current Discharge Characteristics Unit:A (25°C, 77°F)

F.V/Time	2MIN	4MIN	6MIN	8MIN	10MIN	15MIN	20MIN	30MIN	60MIN	90MIN
1.60V	165	113	87.9	72.3	62.4	44.4	35.0	24.9	14.6	10.6
1.67V	142	103	81.7	69.5	58.7	43.5	34.0	24.6	14.4	10.4
1.70V	133	98.6	80.7	67.8	58.1	42.4	33.7	24.3	14.2	10.2
1.75V	119	92.3	75.5	64.3	54.3	41.6	32.9	23.7	14.0	10.1
1.80V	105	83.2	70.0	60.8	51.8	39.8	32.1	23.0	13.6	10.0
1.85V	92.3	76.6	65.2	56.8	49.2	37.6	30.1	22.1	13.5	9.84

## Constant Power Discharge Characteristics Unit:W (25°C, 77°F)

F.V/Time	2MIN	4MIN	6MIN	8MIN	10MIN	15MIN	20MIN	30MIN	60MIN	90MIN
1.60V	1,584	1,171	955	790	691	496	391	282	169	122
1.67V	1,431	1,073	895	761	661	485	382	280	167	121
1.70V	1,369	1,045	884	743	660	475	381	275	165	118
1.75V	1,270	983	832	708	626	468	370	270	161	117
1.80V	1,173	909	781	679	593	453	364	266	159	116
1.85V	1,091	855	734	641	561	426	346	257	156	115

Ratings presented herein are subject to revision without notice. Please refer to [www.csb-battery.com](http://www.csb-battery.com) to confirm the latest version.

### Trickle (or Float) Service Life

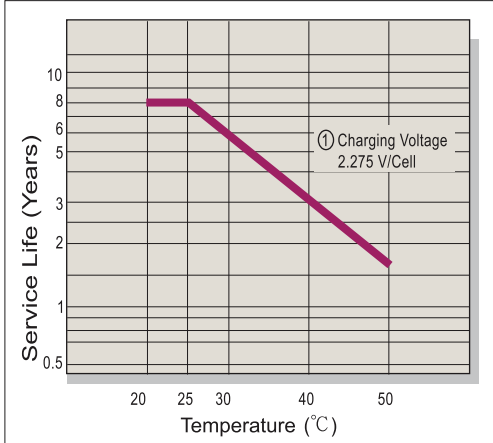

### Capacity Retention Characteristic

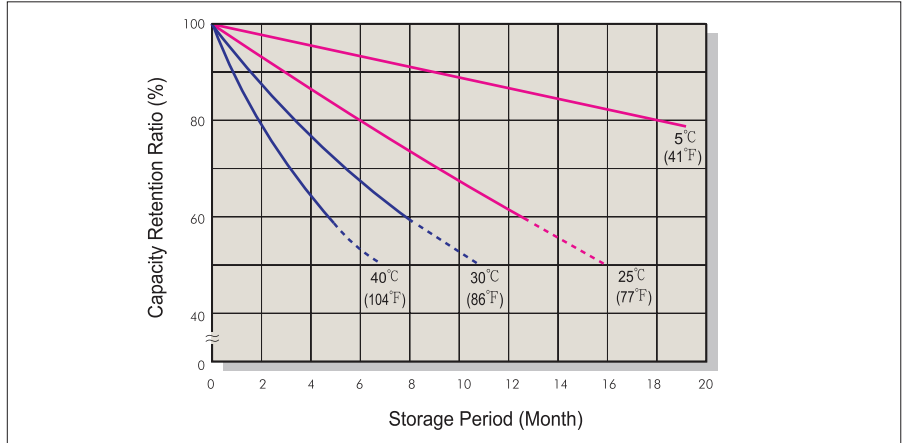

### Battery Voltage and Charge Time for Standby Use

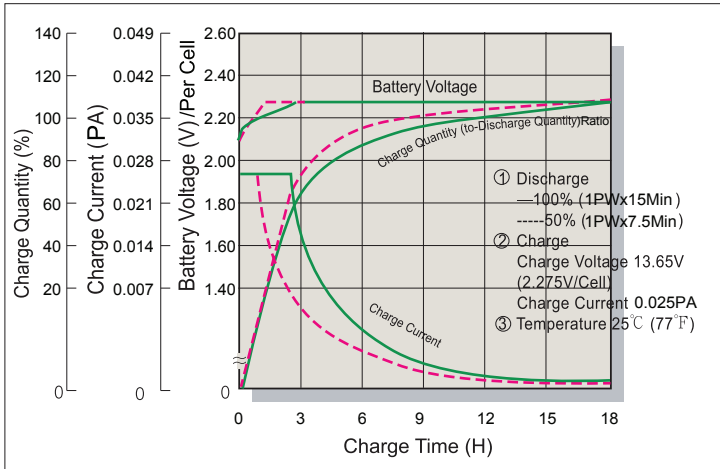

### Cycle Service Life

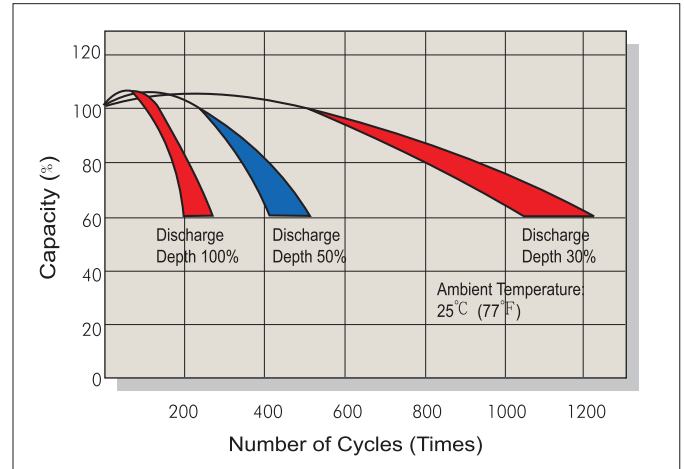

### Battery Voltage and Charge Time for Cycle Use

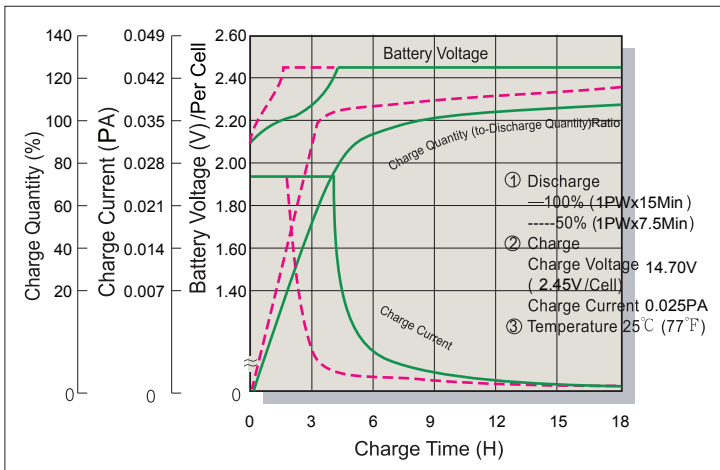

### Terminal Voltage (V) and Discharge Time

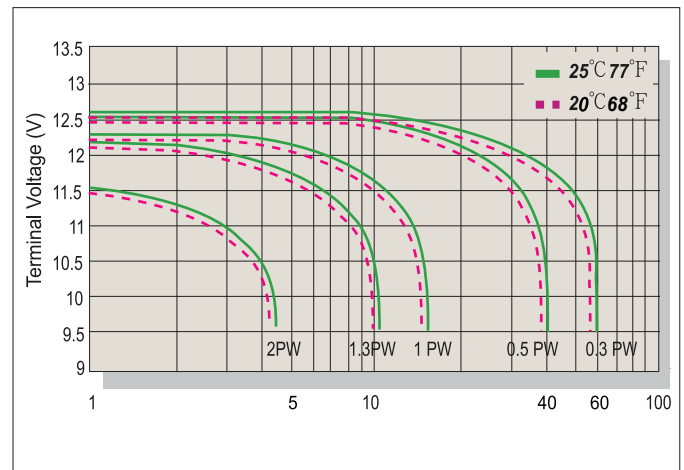

### Charging Procedures

Application	Charge Voltage(V/Cell)			Max.Charge Current
	Temperature	Set Point	Allowable Range	
Cycle Use	25°C(77°F)	2.45	2.40~2.50	0.1PA
Standby	25°C(77°F)	2.275	2.25~2.30	

### Discharge Current VS. Discharge Voltage

Final Discharge Voltage V/Cell	1.75	1.70	1.60	1.30
Discharge Power(W)	0.1P>(W)	0.1P≤(W)<0.25P	0.25P≤(W)<1.0P	(W)≥1.0P

Sales Office URL: [WWW.CSB-BATTERY.COM](http://WWW.CSB-BATTERY.COM)

**GLOBAL HQ**  
**CSB BATTERY CO., LTD. (TAIWAN)**  
 Tel : +886-2-2880-5600  
 Fax : +886-2-2888-3300  
 mail : [service@csb-battery.com.tw](mailto:service@csb-battery.com.tw)

**BEIJING OFFICE. (CHINA)**  
**CSB BATTERY TECHNOLOGIES (BEIJING) CO., LTD.**  
 Tel : +86-10-5820-5336/5338  
 Fax : +86-10-58203053  
 mail : [chinasls@csb-battery.com](mailto:chinasls@csb-battery.com)

**AMERICA HQ**  
**CSB BATTERY TECHNOLOGIES INC. (U.S.A)**  
 Tel : +1-817-244-7777/1-(800)3-CSB-USA(272872)  
 Fax : +1-817-244-4445  
 mail : [csb@csb-battery.com](mailto:csb@csb-battery.com)

**SHANGHAI OFFICE. (CHINA)**  
**CSB BATTERY LOGISTIC (SHANGHAI) CO., LTD.**  
 Tel : +86-21-5046-1622/5046-0833  
 Fax : +86-21-5064-1046  
 mail : [chinasls@csb-battery.com](mailto:chinasls@csb-battery.com)

**EUROPE HQ**  
**CSB Battery Europe BV.**  
 Tel : +31(0)-180-418-140  
 Fax : +31(0)-180-418-327  
 mail : [eurosales@csb-battery.eu](mailto:eurosales@csb-battery.eu)

**SHENZHEN OFFICE. (CHINA)**  
**CSB BATTERY LOGISTIC (SHANGHAI) CO., LTD.**  
 Tel : +86-755-8831-6488/6396/6356  
 Fax : +86-755-8831-6548  
 mail : [she@csb-battery.com.cn](mailto:she@csb-battery.com.cn)