

Powered by



GPL 12520 ▶ 12V 52Ah

GPL 12520 is a general purpose battery up to 10 years in standby service or more than 260 cycles at 100% discharge in cycle service . As with all CSB batteries, all are rechargeable , highly efficient , leak proof and maintenance free.



Specification

Cells Per Unit	6
Voltage Per Unit	12
Capacity	52 Ah @ 20hr-rate to 1.75V per cell @25°C (77°F)
Weight	Approx. 17.60 kg(38.80 lbs)
Maximum Discharge Current	500A(5sec)
Internal Resistance	Approx. 5.9 mΩ
Operating Temperature Range	Discharge: -15°C~50°C (5°F~122°F) Charge: -15°C~40°C (5°F~104°F) Storage: -15°C~40°C (5°F~104°F)
Nominal Operating Temperature Range	25°C±3°C (77°F±5°F)
Float Charging Voltage	13.5 to 13.8 VDC/unit Average at 25°C (77°F)
Recommended Maximum Charging Current Limit	15.6A
Equalization and Cycle Service	14.4 to 15.0 VDC/unit Average at 25°C (77°F)
Self Discharge	CSB Batteries can be stored for more than 6 months at 25°C (77°F). Please charge batteries before using . For higher temperatures the time interval will be shorter.
Terminal	I2-Thread lead alloy recessed terminal to accept M6 bolt
Container Material	Polypropylene(UL 94-HB) & Flammability resistance of (UL 94-V0) can be available upon request.



CSB-manufactured **VRLA** (Absorbent Glass Mat type) batteries are UL-recognized components under UL1989.

CSB is also certified by ISO 9001 and ISO 14001.

Dimensions :	Overall Height (H)	Container height (h)	Length (L)	Width (W)
Unit: mm (inch)	207.3±2.5 (8.16±0.10)	202.3±2.5 (7.96±0.10)	228±2.5 (8.98±0.1)	138.4±1.5 (5.45±0.06)

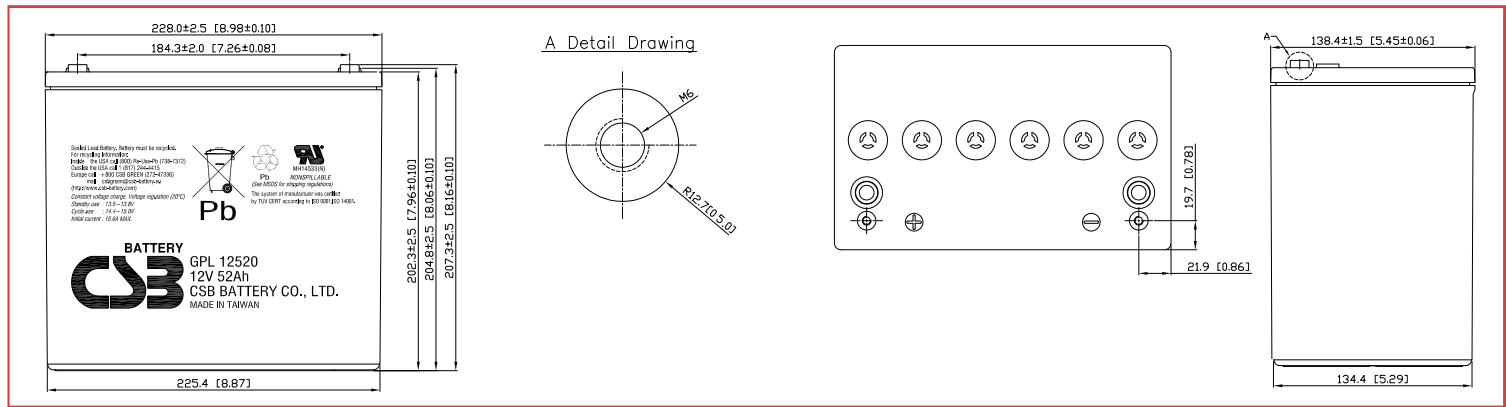

Constant Current Discharge Characteristics Unit:A (25°C,77°F)

F.V/Time	5MIN	10MIN	15MIN	30MIN	60MIN	90MIN	2HR	3HR	5HR	8HR	10HR	20HR
1.60V	225	155	116	67.2	38.5	27.7	21.7	15.2	9.66	6.35	5.17	2.66
1.67V	208	144	110	64.7	38.1	27.4	21.4	15.0	9.57	6.31	5.15	2.65
1.70V	195	138	108	63.6	37.8	27.3	21.3	14.9	9.53	6.28	5.14	2.64
1.75V	177	128	103	61.2	37.0	26.7	20.7	14.7	9.44	6.17	5.08	2.60
1.80V	159	119	95.7	58.7	35.7	26.0	20.3	14.3	9.22	6.04	4.94	2.56
1.85V	142	110	89.3	55.6	33.3	24.8	19.0	13.5	8.71	5.74	4.69	2.43

Constant Power Discharge Characteristics Unit:W (25°C,77°F)

F.V/Time	5MIN	10MIN	15MIN	30MIN	60MIN	90MIN	2HR	3HR	5HR	8HR	10HR	20HR
1.60V	2392	1684	1290	770	447	325	250	176	114	74.7	61.6	31.7
1.67V	2176	1589	1235	748	445	323	247	175	113	74.4	61.2	31.7
1.70V	2081	1540	1208	737	443	322	246	174	112	74.2	60.7	31.4
1.75V	1914	1449	1160	710	434	315	242	171	111	73.9	60.3	31.4
1.80V	1747	1359	1093	683	419	308	235	169	110	72.4	59.5	30.7
1.85V	1584	1258	1031	649	395	295	223	161	105	69.6	56.7	29.4

Ratings presented herein are subject to revision without notice. Please refer to www.csb-battery.com to confirm the latest version.

Trickle (or Float) Service Life

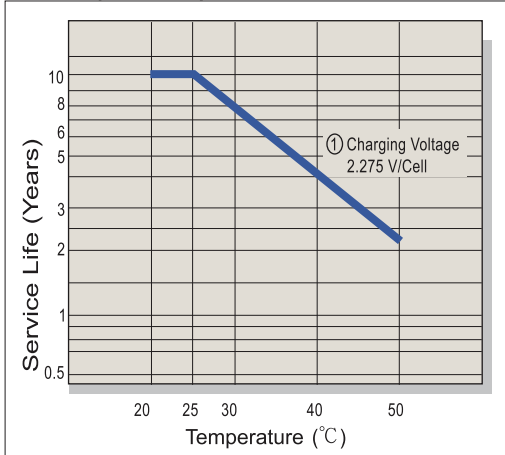

Capacity Retention Characteristic

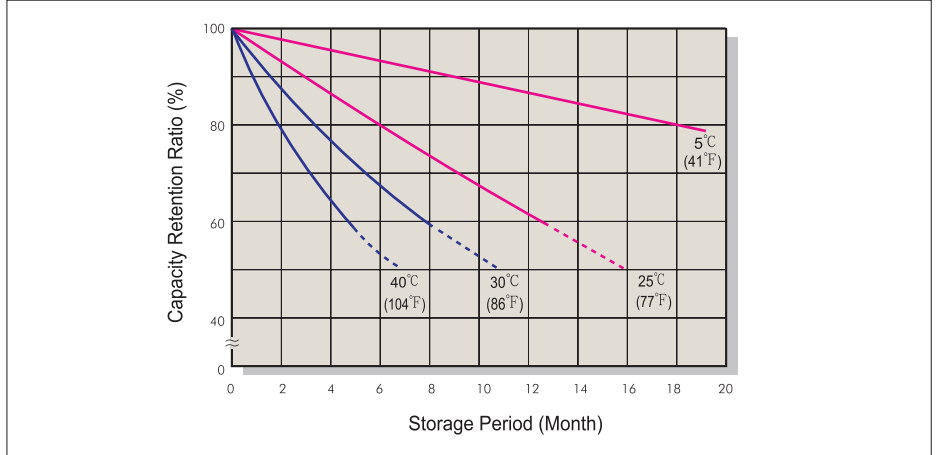

Battery Voltage and Charge Time for Standby Use

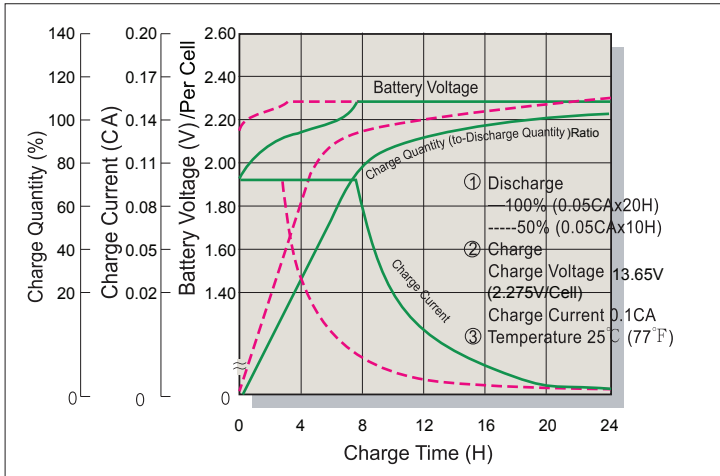

Cycle Service Life

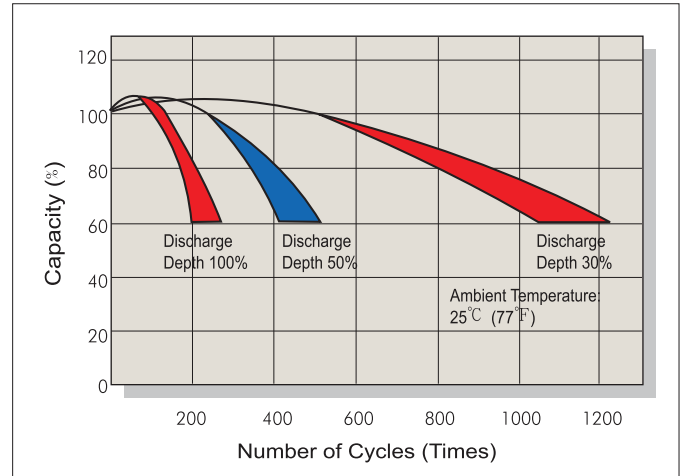

Battery Voltage and Charge Time for Cycle Use

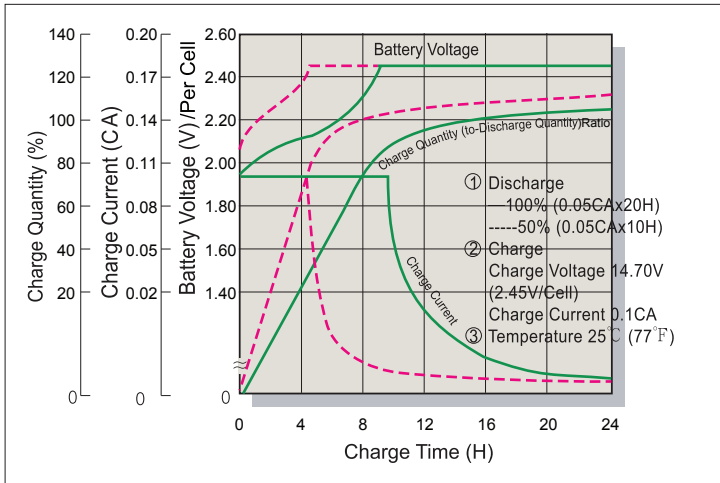

Terminal Voltage (V) and Discharge Time

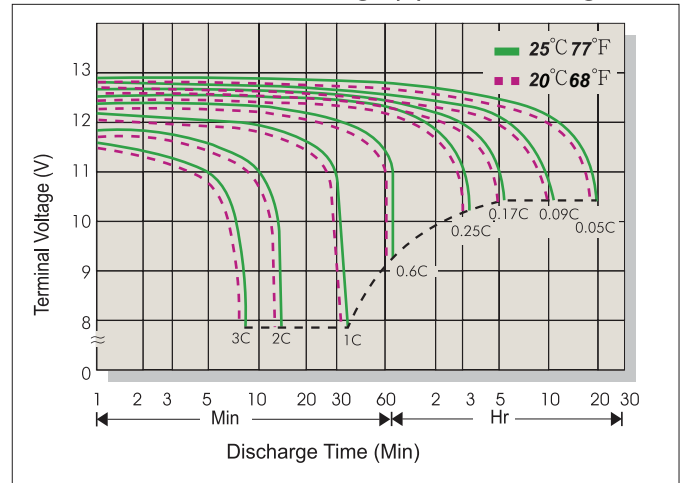

Charging Procedures

Application	Charge Voltage(V/Cell)			Max.Charge Current
	Temperature	Set Point	Allowable Range	
Cycle Use	25°C(77°F)	2.45	2.40~2.50	0.3C
Standby	25°C(77°F)	2.275	2.25~2.30	

Discharge Current VS. Discharge Voltage

Final Discharge Voltage V/Cell	1.75	1.70	1.60	1.30
Discharge Current(A)	0.2C>(A)	0.2C<(A)<0.5C	0.5C<(A)<1.0C	(A)>1.0C

Sales Office URL: WWW.CSB-BATTERY.COM

GLOBAL HQ CSB BATTERY CO., LTD. (TAIWAN)

Tel : +886-2-2880-5600
 Fax : +886-2-2888-3300
 mail : service@csb-battery.com.tw

BEIJING OFFICE. (CHINA)

CSB BATTERY TECHNOLOGIES (BEIJING) CO., LTD.
 Tel : +86-10-5820-5336/5338
 Fax : +86-10-58203053
 mail : chinasl@csb-battery.com

AMERICA HQ

CSB BATTERY TECHNOLOGIES INC. (U.S.A)
 Tel : +1-817-244-7777/1-(800)3-CSB-USA(272872)
 Fax : +1-817-244-4445
 mail : csb@csb-battery.com

SHANGHAI OFFICE. (CHINA)

CSB BATTERY LOGISTIC (SHANGHAI) CO., LTD.
 Tel : +86-21-5046-1622/5046-0833
 Fax : +86-21-5064-1046
 mail : chinasl@csb-battery.com

EUROPE HQ

CSB Battery Europe BV.
 Tel : +31(0)-180-418-140
 Fax : +31(0)-180-418-327
 mail : eurosales@csb-battery.eu

SHENZHEN OFFICE. (CHINA)

CSB BATTERY LOGISTIC (SHANGHAI) CO., LTD.
 Tel : +86-755-8831-6488/6396/6356
 Fax : +86-755-8831-6548
 mail : she@csb-battery.com.cn